

2017
KATALOG
LUI



DOOR LIFE
www.doorlifeasensor.com

V İ Z Y O N & M İ S Y O N

Vizyon, beyindeki radarın, yürekteki gözün sağladığı bir görüş yeteneğidir. Vizyon, geleceğini yakalama arzusu ve iradesidir.

Vizyon ne hayaldir, ne de gerçekleşmeyecek bir düşünüş. Vizyon, mevcudu çok iyi analiz etmek, potansiyeli hissetmek ve geleceği görmek demektir.

Sektörün üreticilere çok uzak durduğu, birbirlerinden herhangi bir beklentilerinin olmadığı o günlerde vizyonunu anlatmaya çalışan DOORLIFE'a, dudak bükken, anlatılanları, yazılanları gerçekleşmeyecek düşler olarak değerlendirenler şimdi DOORLIFE'ın hakkını teslim ediyorlar.

Çünkü tek başına başlanan bu yürüyüşte vizyonun misyon haline getirilmesi için kadrolaşarak, karşılaşılan engeller karşısında inançsızlığa kapılanlarla yollarını ayırarak bıkmadan, usanmadan, yılmınlığa düşmeden büyük bir inanç, özgüven ve cesaretle, gittikçe büyüyen bir katılımıla DOORLIFE, vizyonunu hayata geçirmiştir.

Ve şimdi...

Her geçen gün genişlettiğimiz ürün yelpazesi ile sektörünün en büyük şirketi olmaya kararlıyız. Müşterilerimizin memnuniyeti her zaman ana ilkimiz olmuştur. En iyi hizmeti sizlere sunabilmek için yatırımlarımıza aralıksız devam ederek markamızı en iyi noktalara taşıyacağız.

DOORLIFE, " olmak" öncelikli bir korumacılık yerine "yapmak" öncelikli bir gelişmecilikten yana tavrının doğal sonucu olarak yenilenmiş vizyonu, sizlerle birlikte varacağı yeni hedeflerin vizyonu, genç kadrosunun dinamizmi ile yeni, yepyeni KAPI MODELLERİ ile karşınızda olmaya devam edecektir.



VISION & MISSION

Vision is an ability of seeing thanks to the radar in one's brain and the eyes in one's heart. Vision is the desire and will to catch the reality of the future. Vision is neither a raw fantasy, nor an impossible dream. Vision is being able to analyze the current situation very well, feeling the potential and seeing the future.

Those who evaluated the things, which we explained and wrote, as impossible fantasies and who showed displeasure to DOORLIFE who tried to tell them its vision in the old days when the sector and the producers had no expectations and were standing very far away from each other, are now acknowledging the success of DOORLIFE.

Because DOORLIFE managed to realize its vision thanks to constantly growing participation with self-confidence, courage and faith, persistently and without fear, by organizing the personnel in order to turn the vision into the mission during this long path we started alone, and by parting our ways with those who did not have faith in front of the obstacles.

And now...

We are determined to become the biggest company of the the sector thanks to our product range we extend with each passing day. Satisfaction of our customers has always interruption in order to provide you with the best services and to bring our trademark to the best position.

DOORLIFE will continue to be with you with new, brand-new DOOR MODELS thanks to dynamism of young personnel, the mission of new goals are going to reach with you, the renewed vision as thenatural result of DOORLIFE's approach which supports improvement with priority of "doing" instead of proted of protectionism with "being" priority.



**KALİTE
KAPIDA
BAŞLAR**

QUALITY STARTS FROM DOORLIFE

İÇİNDEKİLER / INDEX

YARI OTOMATİK KAPILAR / SEMI AUTOMATIC DOORS	08 ■
OTOMATİK KAPILAR / AUTOMATIC DOORS	39 ■
KRAMER KAPILAR / KRAMER FOLDING DOORS	44 ■
HİDROLİK KARKAS / HYDROLIC CARCASS	48 ■
DİĞER ÜRÜNLERİMİZ / OTHER PRODUCTS	51 ■
• ARAÇ KALDIRMA PLATFORMU / VEHICLE LIFTING PLATFORM	
• PANOLAR / CABINETS	
• KORUMA KAPAKLARI / PROTECTION COVERS	
DİĞER KAPI SEÇENEKLERİ / OTHER MODELS	54 ■
RENK SEÇENEKLERİ / RAL COLORS	57 ■
KAPI MODELLERİ / DOOR MODELS	59 ■
KOL MODELLERİ / HANDLE MODELS	60 ■
KODLAMA SİSTEMİ / CODE SYSTEM	61 ■
TEKNİK BİLGİLER / TECHNICAL INFORMATION	62 ■
BELGE VE SERTİFİKALAR / CERTIFICATES	64 ■

Dostluğa açılan kapılar | The doors open to friendship





aso



DOOR LIFE

WWW.DOORLIFEASANSOR.COM



A MODEL
YARI OTOMATİK KAPI
SEMI AUTOMATIC DOOR



3004



7032

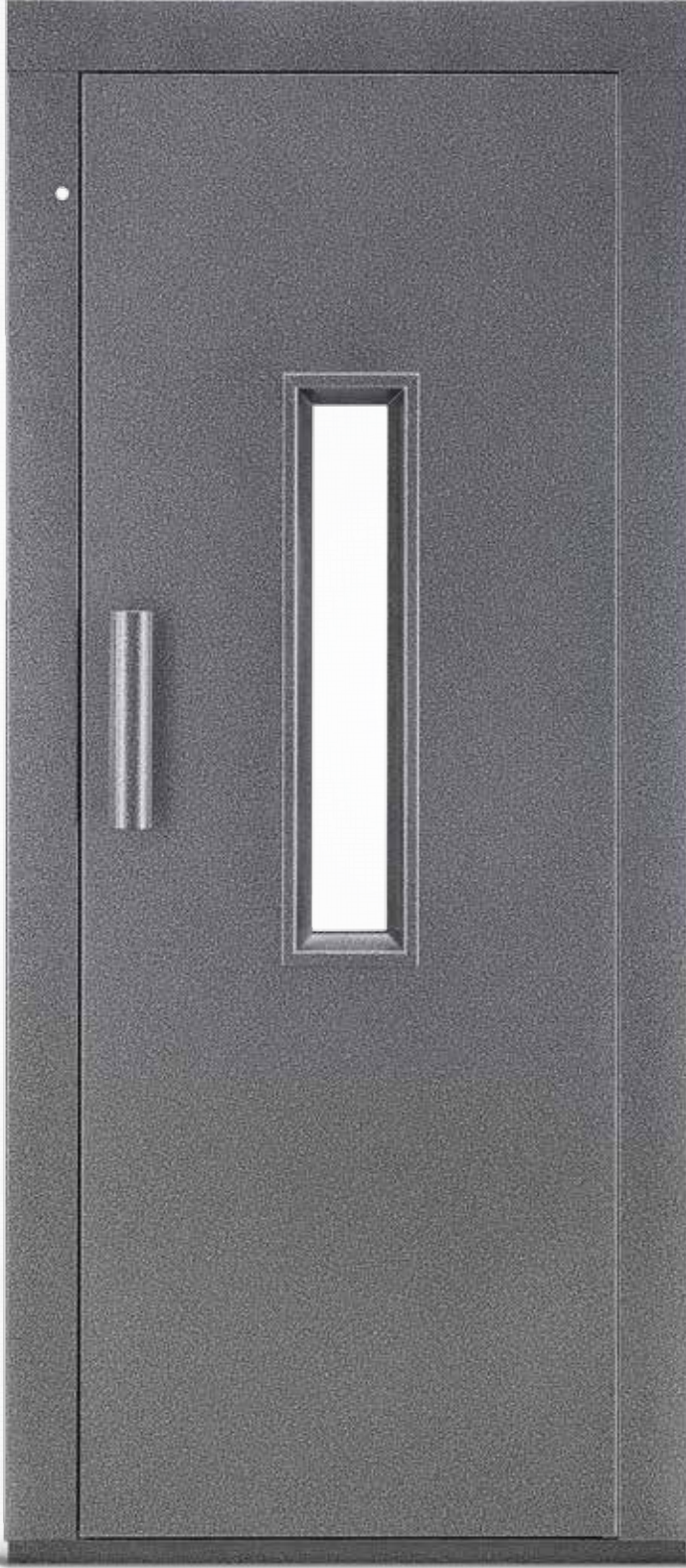

A MODEL
YARI OTOMATİK KAPI
SEMI AUTOMATIC DOOR



GÜMÜŞ
SILVER



A MODEL
YARI OTOMATİK KAPI
SEMI AUTOMATIC DOOR

7032



A MODEL
YARI OTOMATİK KAPI
SEMI AUTOMATIC DOOR



KAYIN KAPLAMA
BEECH PAINTING

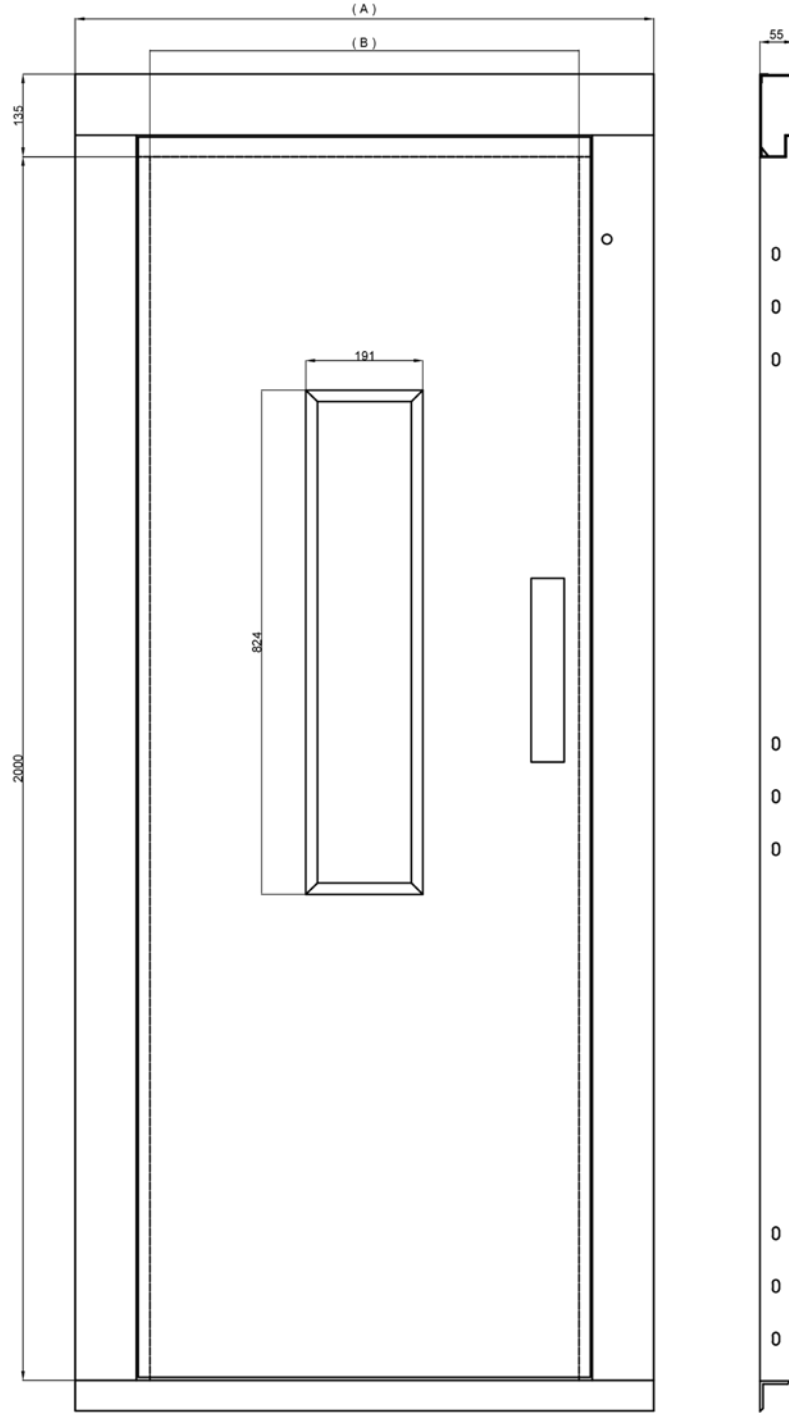

	A	B	
700mm KAPI / DOOR	944mm	700mm	GİRİŞ YÜKSEKLİK ENTRANCE HEIGHT 2000mm
800mm KAPI / DOOR	1044mm	800mm	
900mm KAPI / DOOR	1144mm	900mm	

DİĞER TALEP EDİLEN ÖLÇÜLER ÖZEL ÜRETİME GİRMEKTEDİR.
EXCEPT FROM THESE MEASUREMENTS ARE SPECIAL MANUFACTURING.

A MODEL
TEKNİK ÇİZİM
TECHNICAL DRAWING

* Diğer renk ve desen seçenekleri için 57 - 58' uncu sayfalara bakınız

* For other color and design preferences with this product you can see page between 57 - 58.



D MODEL
YARI OTOMATİK KAPI
SEMI AUTOMATIC DOOR

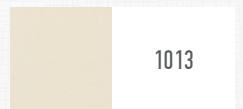

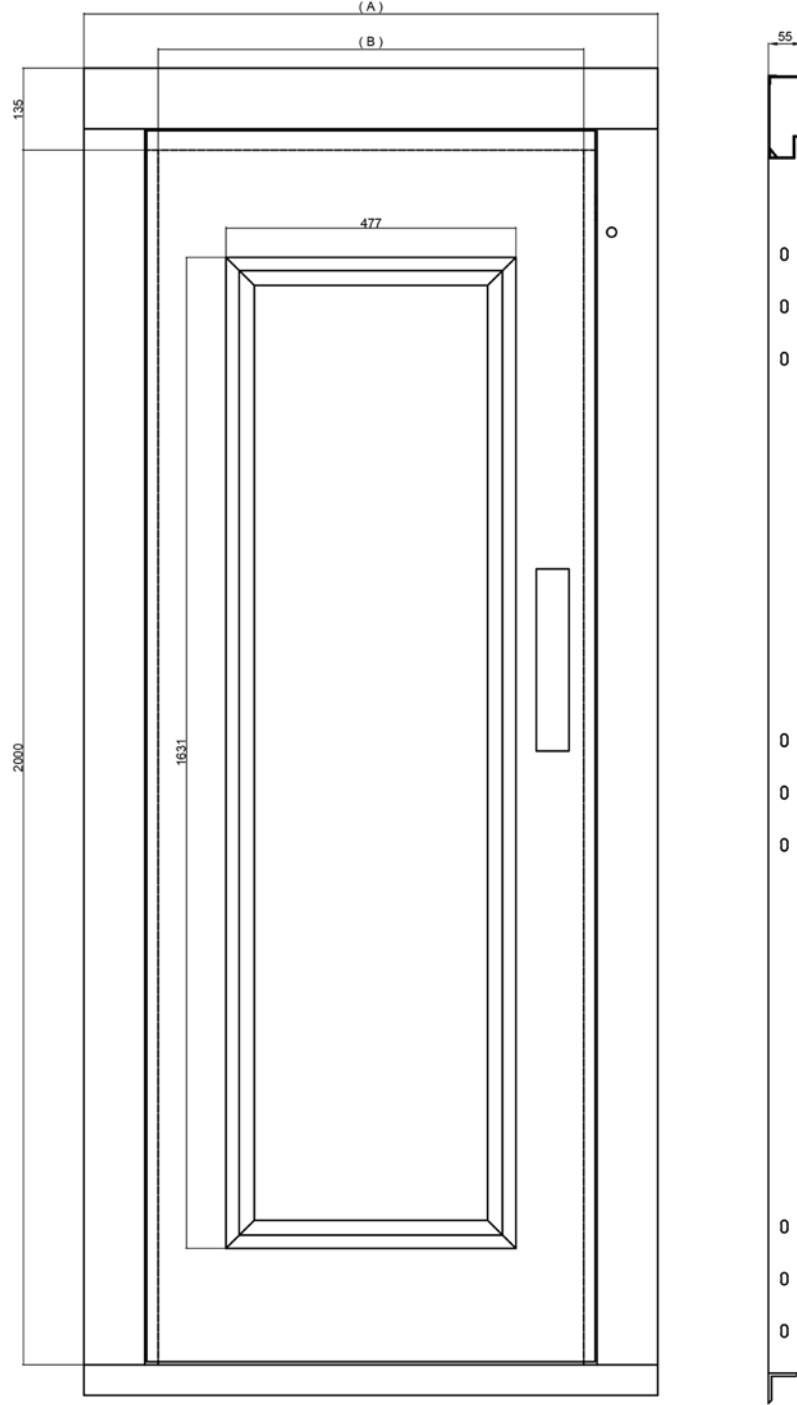

	A	B	
700mm KAPI / DOOR	944mm	700mm	GİRİŞ YÜKSEKLİK ENTRANCE HEIGHT 2000mm
800mm KAPI / DOOR	1044mm	800mm	
900mm KAPI / DOOR	1144mm	900mm	

DİĞER TALEP EDİLEN ÖLÇÜLER ÖZEL ÜRETİME GİRMEKTEDİR.
EXCEPT FROM THESE MEASUREMENTS ARE SPECIAL MANUFACTURING.

* Diğer renk ve desen seçenekleri için 57 - 58' uncu sayfalara bakınız

* For other color and design preferences with this product you can see page between 57 - 58.

D MODEL
TEKNİK ÇİZİM
TECHNICAL DRAWING



E MODEL
YARI OTOMATİK KAPI
SEMI AUTOMATIC DOOR

9016

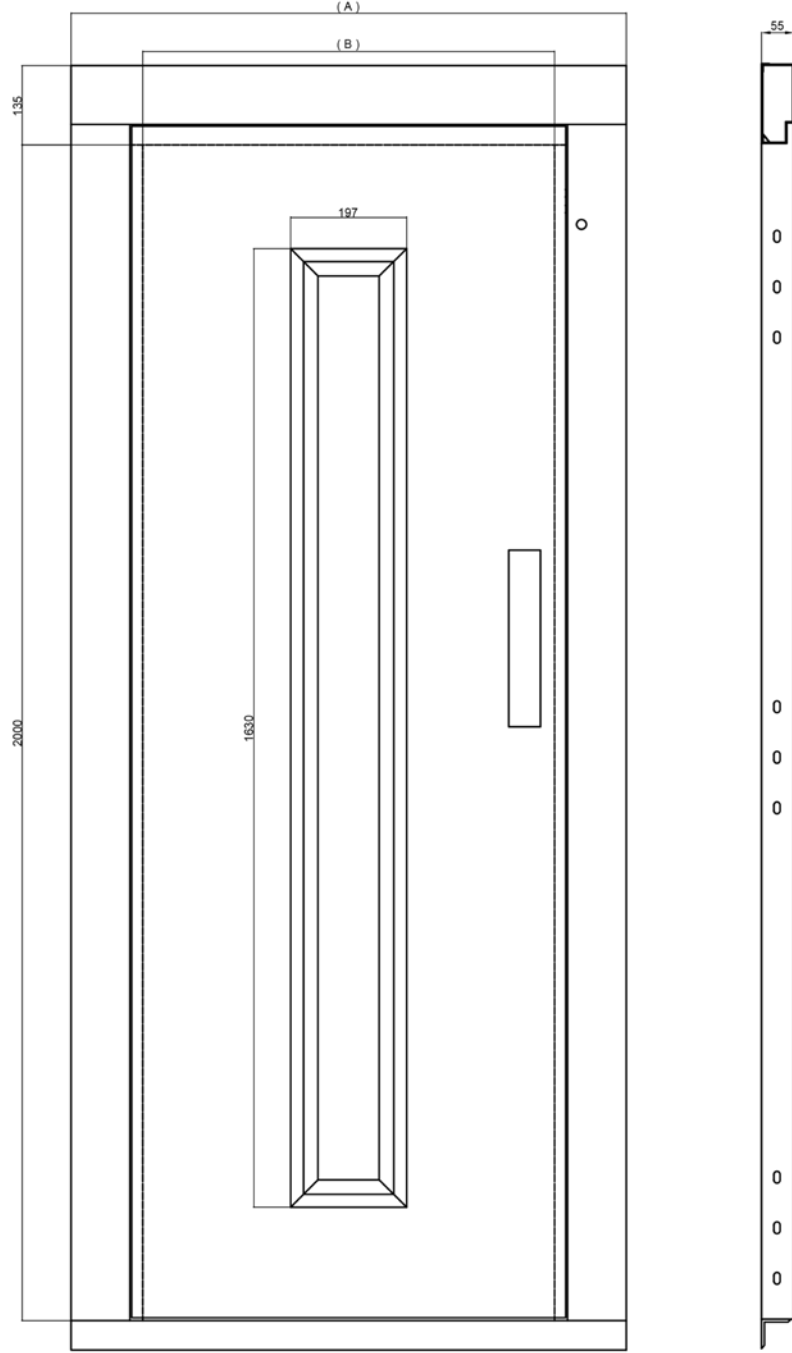

	A	B	
700mm KAPI / DOOR	944mm	700mm	GİRİŞ YÜKSEKLİK ENTRANCE HEIGHT 2000mm
800mm KAPI / DOOR	1044mm	800mm	
900mm KAPI / DOOR	1144mm	900mm	

**DİĞER TALEP EDİLEN ÖLÇÜLER ÖZEL ÜRETİME GİRMEKTEDİR.
EXCEPT FROM THESE MEASUREMENTS ARE SPECIAL MANUFACTURING.**

E MODEL
TEKNİK ÇİZİM
TECHNICAL DRAWING

* Diğer renk ve desen seçenekleri için 57 - 58' uncu sayfalara bakınız

* For other color and design preferences with this product you can see page between 57 - 58.



F MODEL
YARI OTOMATİK KAPI
SEMI AUTOMATIC DOOR

Yıldız

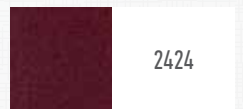

2424

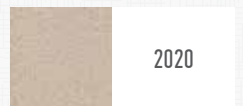

2020

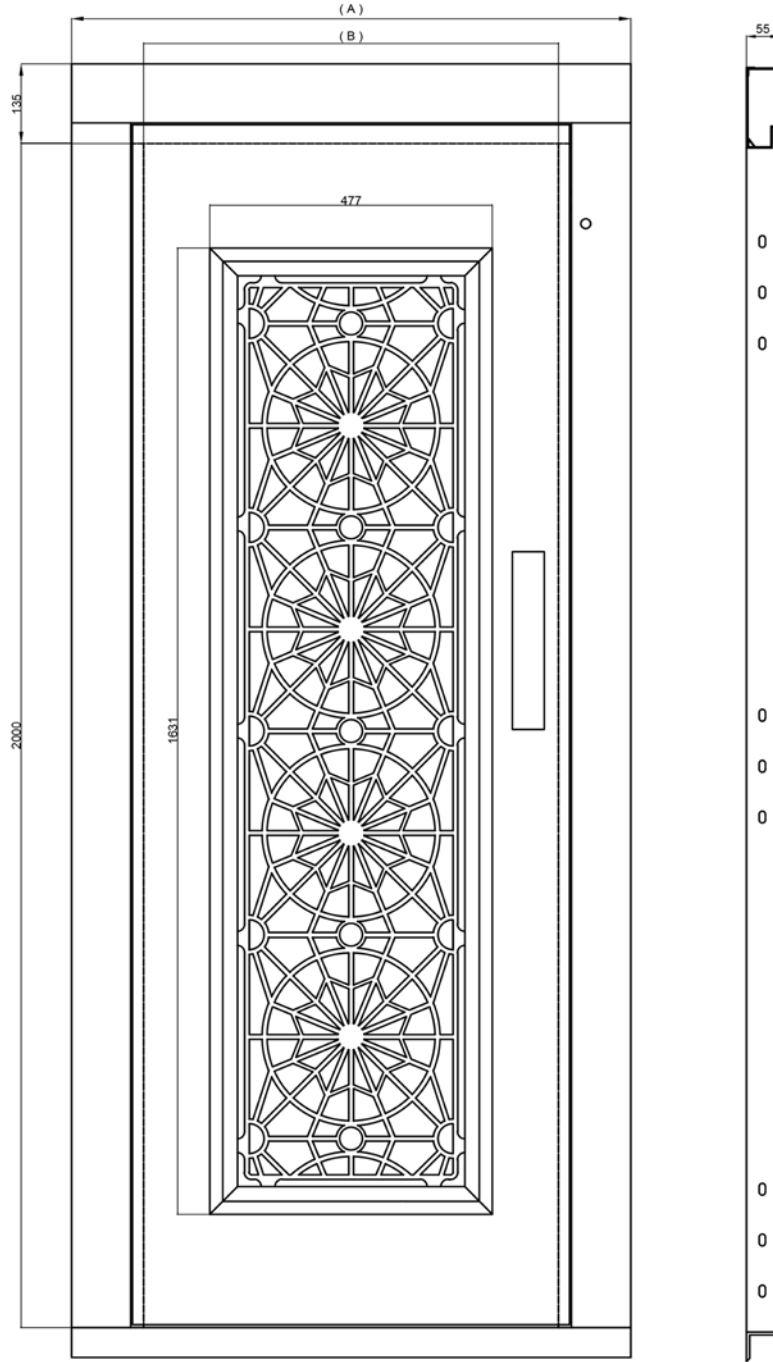

	A	B	
700mm KAPI / DOOR	944mm	700mm	GİRİŞ YÜKSEKLİK ENTRANCE HEIGHT 2000mm
800mm KAPI / DOOR	1044mm	800mm	
900mm KAPI / DOOR	1144mm	900mm	

DİĞER TALEP EDİLEN ÖLÇÜLER ÖZEL ÜRETİME GİRMEKTEDİR.
EXCEPT FROM THESE MEASUREMENTS ARE SPECIAL MANUFACTURING.

F MODEL
TEKNİK ÇİZİM
TECHNICAL DRAWING

* Diğer renk ve desen seçenekleri için 57 - 58' uncu sayfalara bakınız

* For other color and design preferences with this product you can see page between 57 - 58.

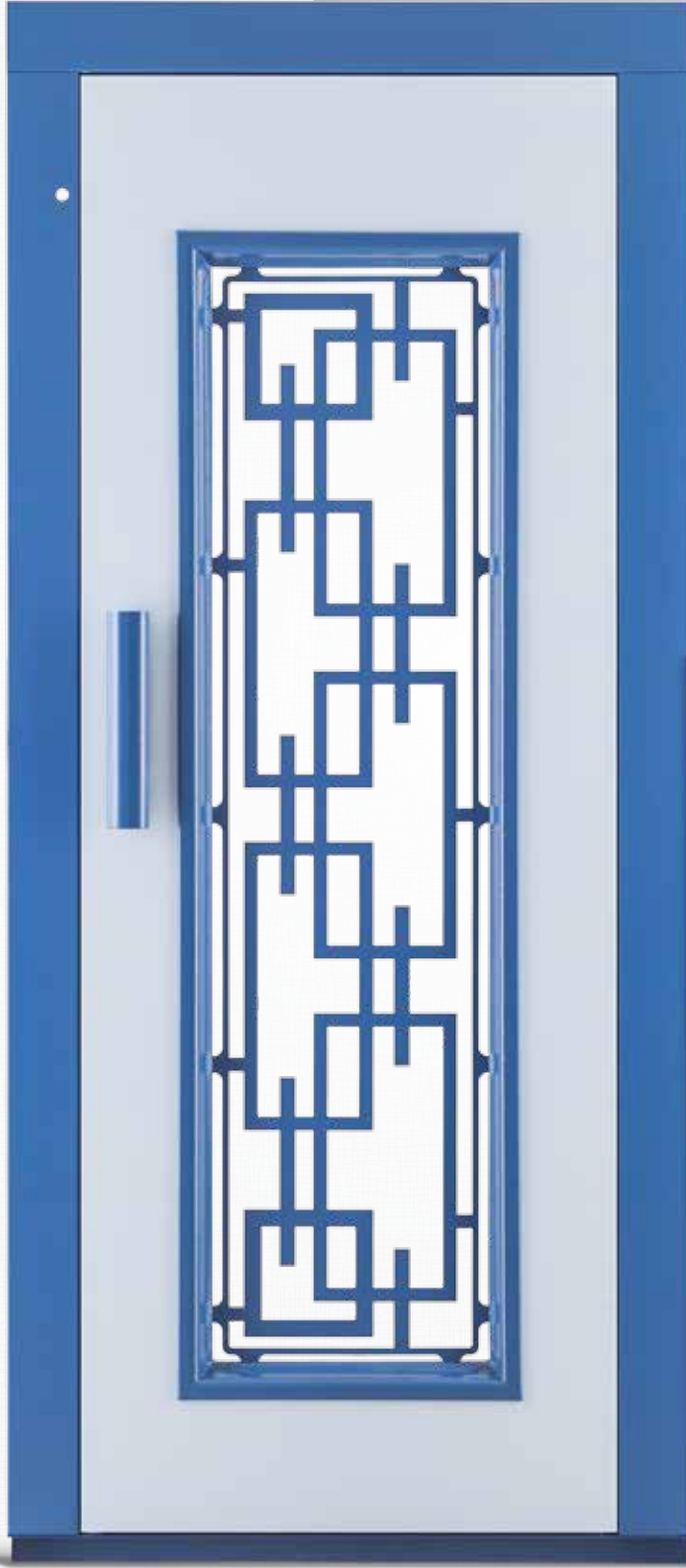

F MODEL
YARI OTOMATİK KAPI
SEMI AUTOMATIC DOOR

Asimetrik

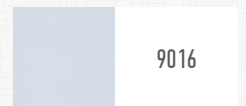

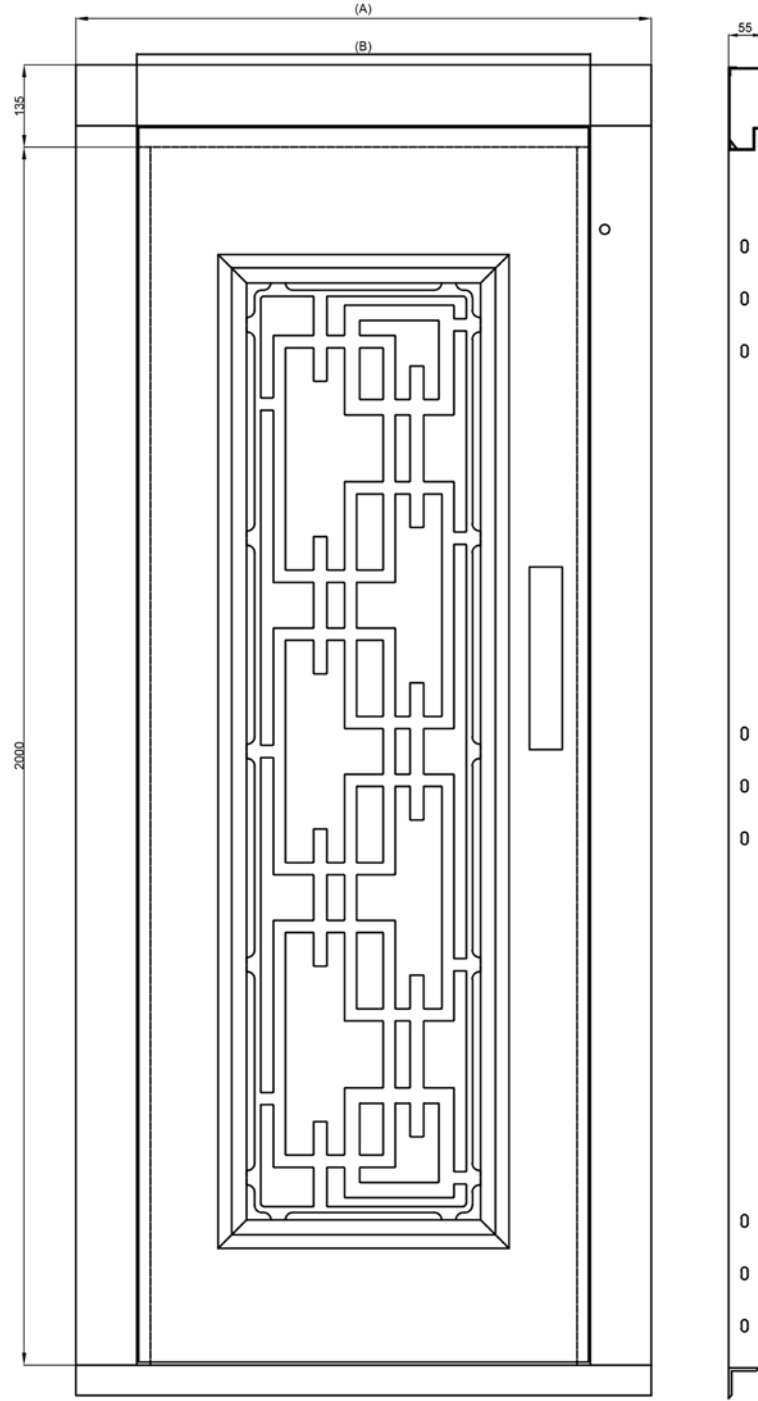

	A	B	
700mm KAPI / DOOR	944mm	700mm	GİRİŞ YÜKSEKLİK ENTRANCE HEIGHT 2000mm
800mm KAPI / DOOR	1044mm	800mm	
900mm KAPI / DOOR	1144mm	900mm	

DİĞER TALEP EDİLEN ÖLÇÜLER ÖZEL ÜRETİME GİRMEKTEDİR.
EXCEPT FROM THESE MEASUREMENTS ARE SPECIAL MANUFACTURING.

F MODEL
TEKNİK ÇİZİM
TECHNICAL DRAWING

* Diğer renk ve desen seçenekleri için 57 - 58' uncu sayfalara bakınız

* For other color and design preferences with this product you can see page between 57 - 58.



F MODEL
YARI OTOMATİK KAPI
SEMI AUTOMATIC DOOR

Taç



9016

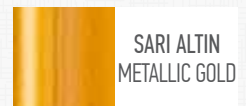

SARI ALTIN
METALLIC GOLD

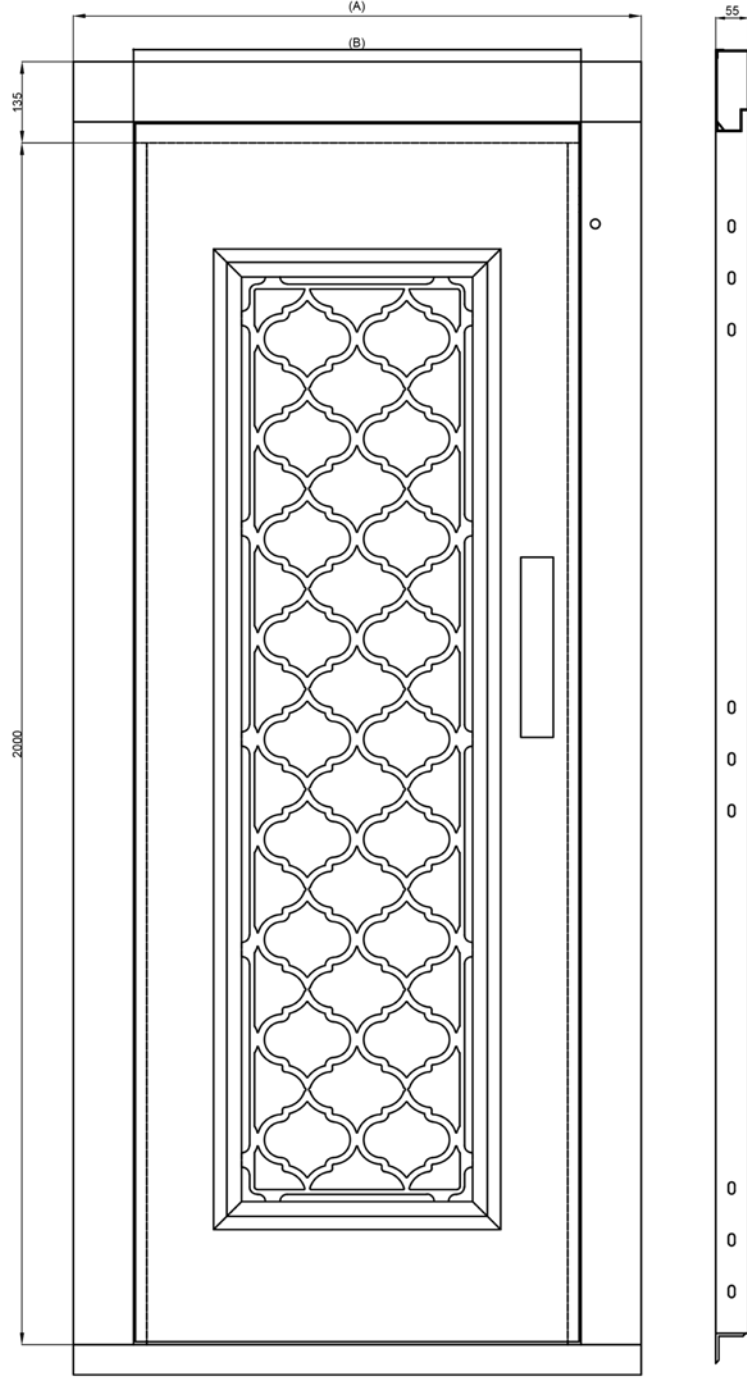

	A	B	
700mm KAPI / DOOR	944mm	700mm	GİRİŞ YÜKSEKLİK ENTRANCE HEIGHT 2000mm
800mm KAPI / DOOR	1044mm	800mm	
900mm KAPI / DOOR	1144mm	900mm	

DİĞER TALEP EDİLEN ÖLÇÜLER ÖZEL ÜRETİME GİRMEKTEDİR.
EXCEPT FROM THESE MEASUREMENTS ARE SPECIAL MANUFACTURING.

* Diğer renk ve desen seçenekleri için 57 - 58' uncu sayfalara bakınız

* For other color and design preferences with this product you can see page between 57 - 58.

F MODEL
TEKNİK ÇİZİM
TECHNICAL DRAWING



G MODEL
YARI OTOMATİK KAPI
SEMI AUTOMATIC DOOR



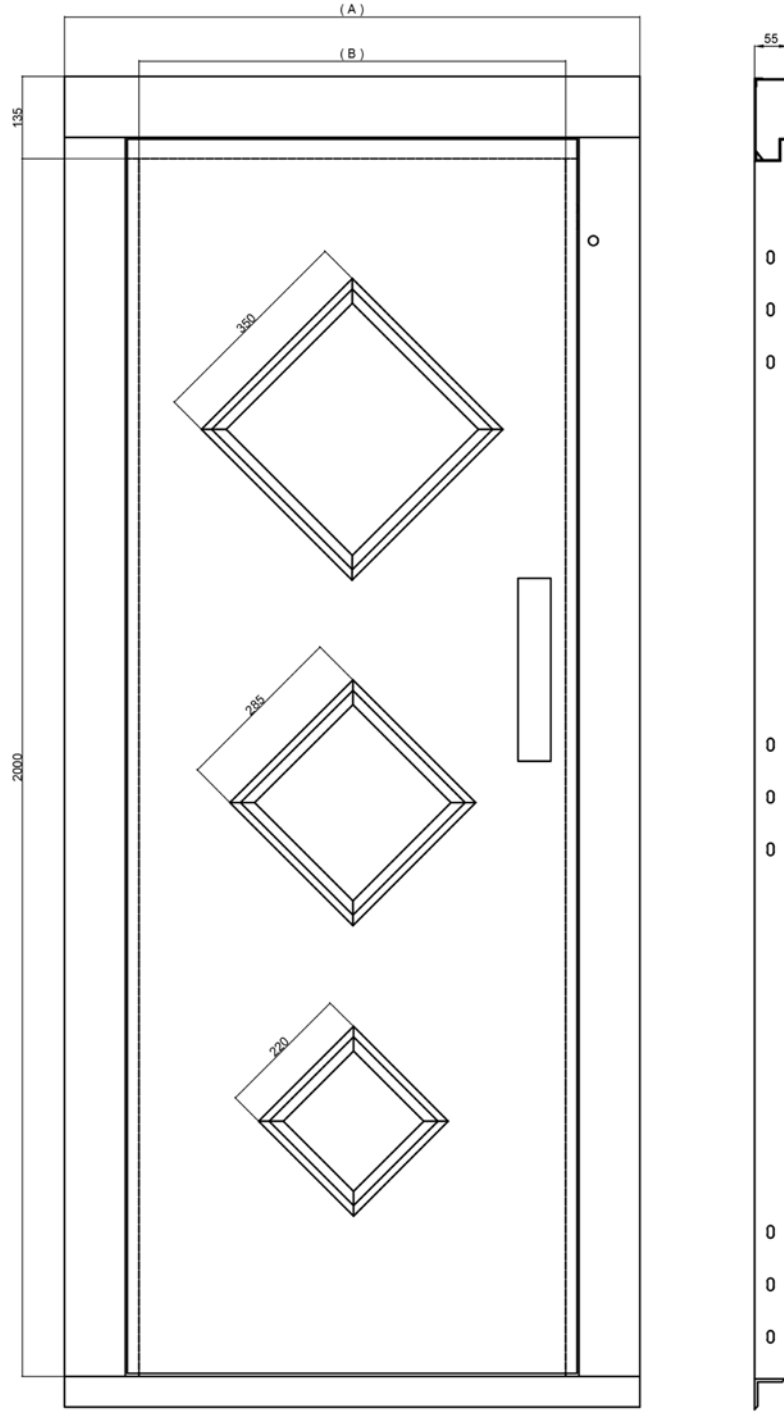

	A	B	
700mm KAPI / DOOR	944mm	700mm	GİRİŞ YÜKSEKLİK ENTRANCE HEIGHT 2000mm
800mm KAPI / DOOR	1044mm	800mm	
900mm KAPI / DOOR	1144mm	900mm	

DİĞER TALEP EDİLEN ÖLÇÜLER ÖZEL ÜRETİME GİRMEKTEDİR.
EXCEPT FROM THESE MEASUREMENTS ARE SPECIAL MANUFACTURING.

F MODEL
TEKNİK ÇİZİM
TECHNICAL DRAWING

* Diğer renk ve desen seçenekleri için 57 - 58' uncu sayfalara bakınız

* For other color and design preferences with this product you can see page between 57 - 58.



H MODEL
YARI OTOMATİK KAPI
SEMI AUTOMATIC DOOR

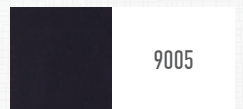

9005



9016

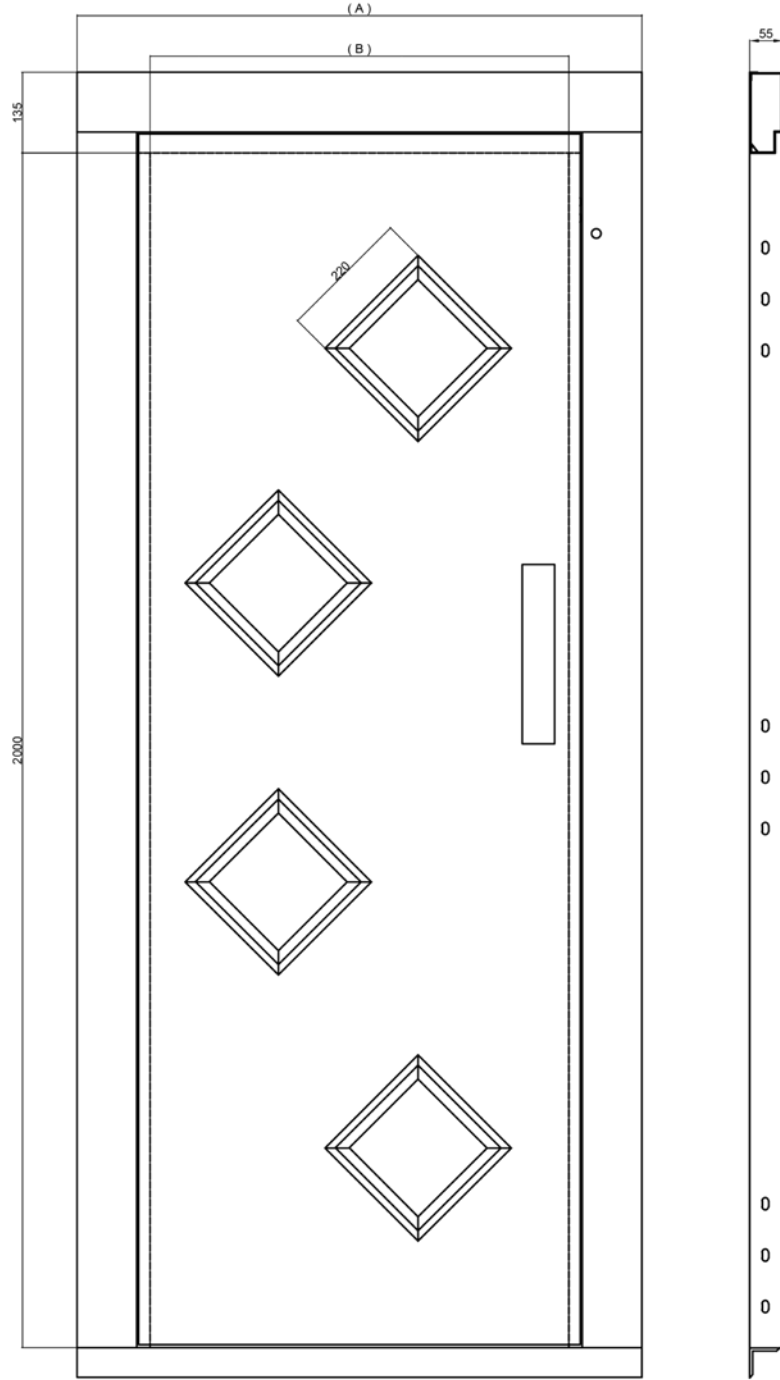

	A	B	
700mm KAPI / DOOR	944mm	700mm	GİRİŞ YÜKSEKLİK ENTRANCE HEIGHT 2000mm
800mm KAPI / DOOR	1044mm	800mm	
900mm KAPI / DOOR	1144mm	900mm	

DİĞER TALEP EDİLEN ÖLÇÜLER ÖZEL ÜRETİME GİRMEKTEDİR.
EXCEPT FROM THESE MEASUREMENTS ARE SPECIAL MANUFACTURING.

* Diğer renk ve desen seçenekleri için 57 - 58' uncu sayfalara bakınız

* For other color and design preferences with this product you can see page between 57 - 58.

F MODEL
TEKNİK ÇİZİM
TECHNICAL DRAWING



K MODEL
YARI OTOMATİK KAPI
SEMI AUTOMATIC DOOR

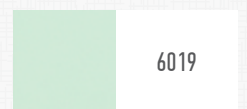
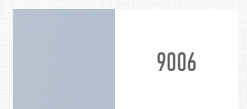

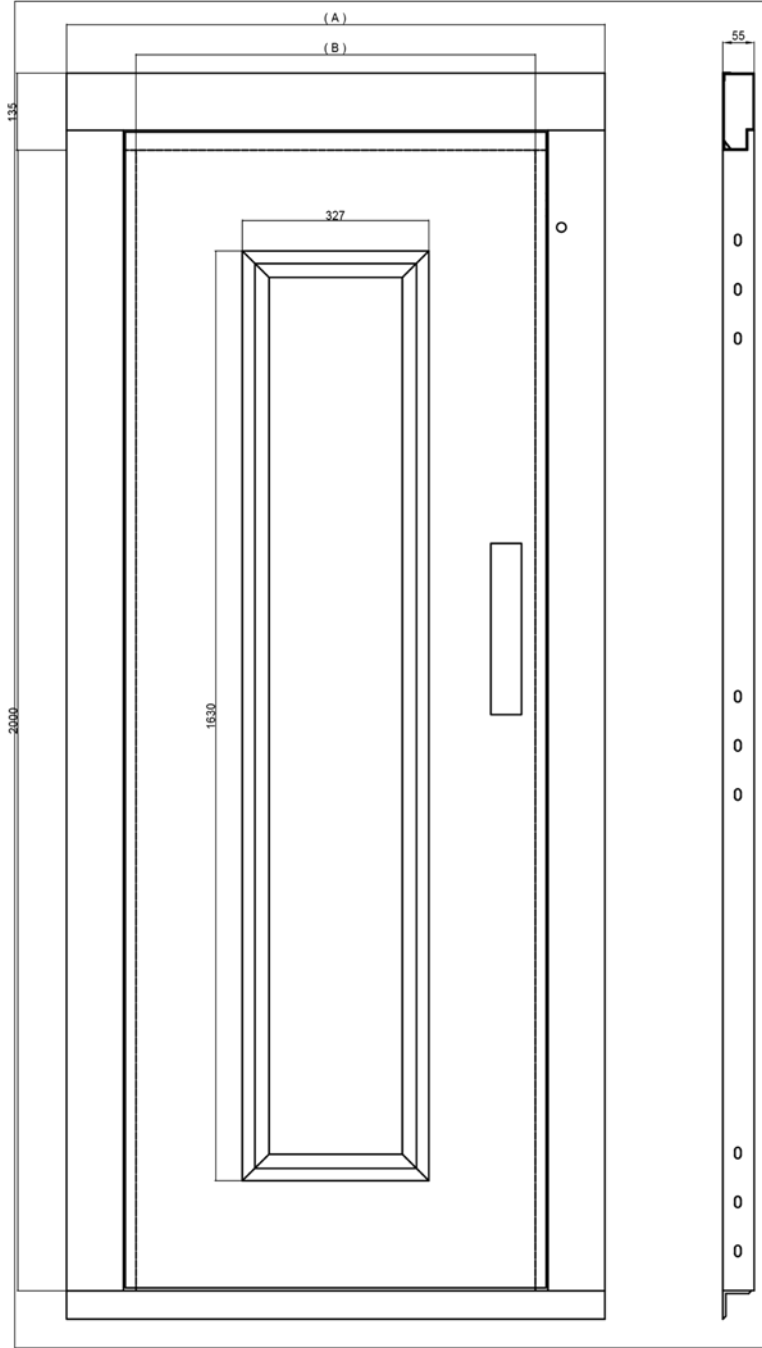

	A	B	
700mm KAPI / DOOR	944mm	700mm	GİRİŞ YÜKSEKLİK ENTRANCE HEIGHT 2000mm
800mm KAPI / DOOR	1044mm	800mm	
900mm KAPI / DOOR	1144mm	900mm	

DİĞER TALEP EDİLEN ÖLÇÜLER ÖZEL ÜRETİME GİRMEKTEDİR.
EXCEPT FROM THESE MEASUREMENTS ARE SPECIAL MANUFACTURING.

K MODEL
TEKNİK ÇİZİM
TECHNICAL DRAWING

* Diğer renk ve desen seçenekleri için 57 - 58' uncu sayfalara bakınız

* For other color and design preferences with this product you can see page between 57 - 58.

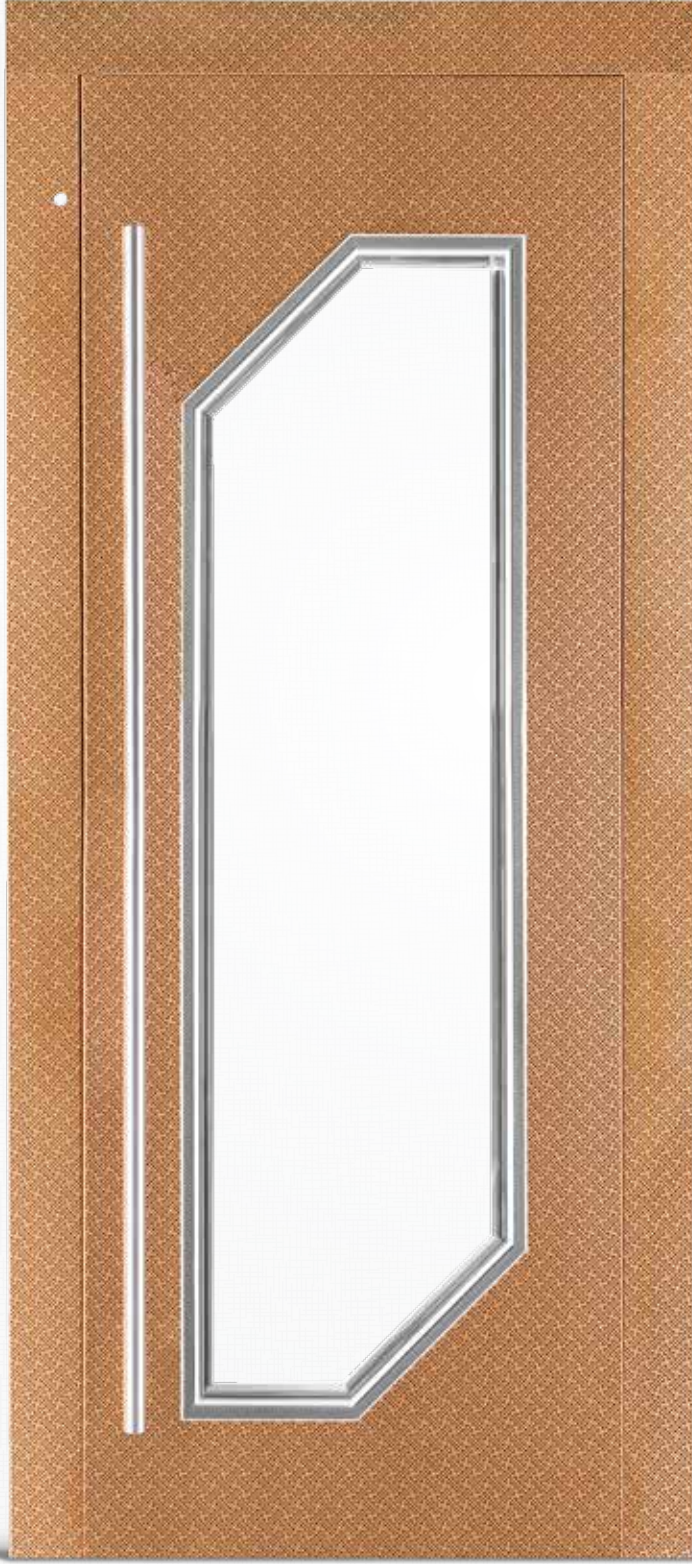

P MODEL
YARI OTOMATİK KAPI
SEMI AUTOMATIC DOOR



ALTIN KAPLAMA
GOLD COVERING

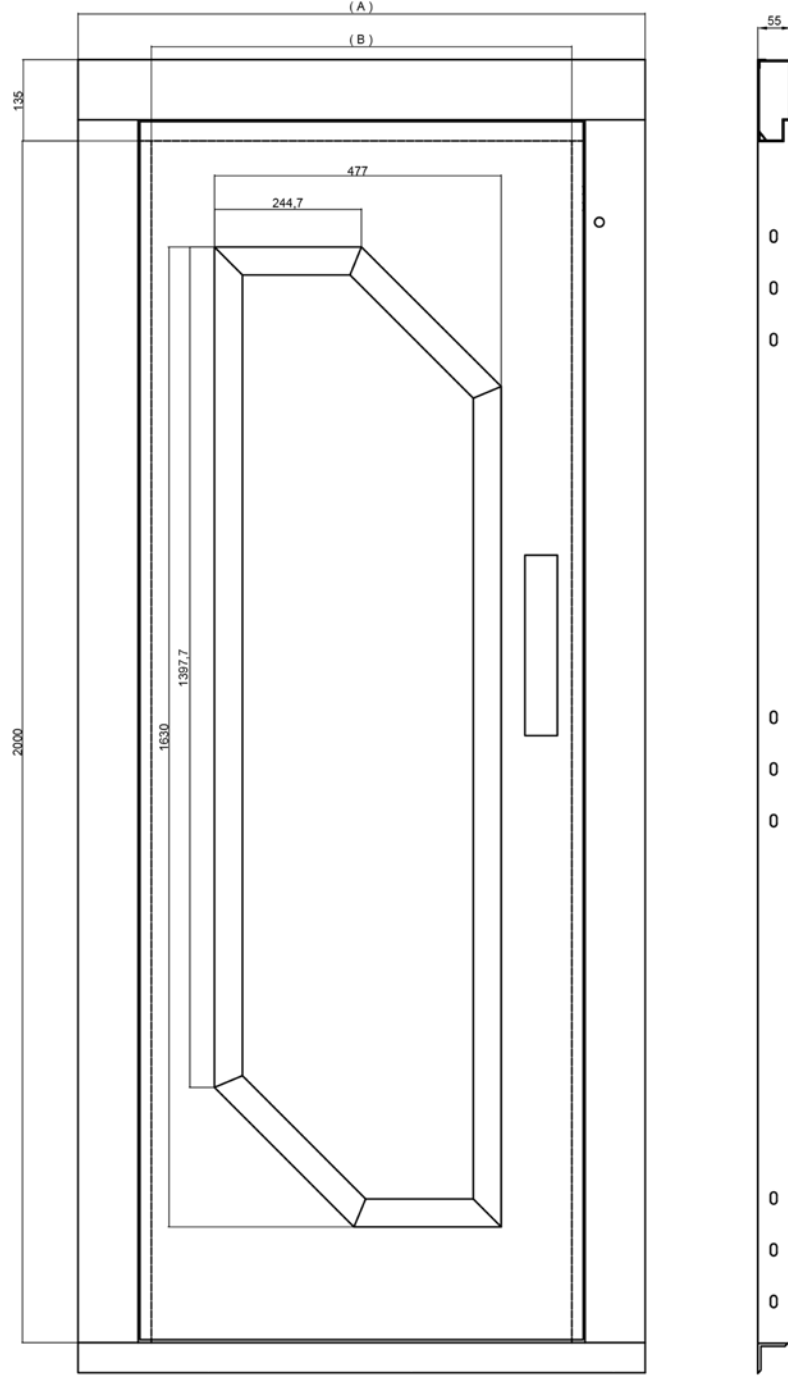

	A	B	
700mm KAPI / DOOR	944mm	700mm	GİRİŞ YÜKSEKLİK ENTRANCE HEIGHT 2000mm
800mm KAPI / DOOR	1044mm	800mm	
900mm KAPI / DOOR	1144mm	900mm	

DİĞER TALEP EDİLEN ÖLÇÜLER ÖZEL ÜRETİME GİRMEKTEDİR.
EXCEPT FROM THESE MEASUREMENTS ARE SPECIAL MANUFACTURING.

P MODEL
TEKNİK ÇİZİM
TECHNICAL DRAWING

* Diğer renk ve desen seçenekleri için 57 - 58' uncu sayfalara bakınız

* For other color and design preferences with this product you can see page between 57 - 58.



N MODEL
YARI OTOMATİK KAPI
SEMI AUTOMATIC DOOR

SATİNE
PASLANMAZ
STAINLESS STEEL

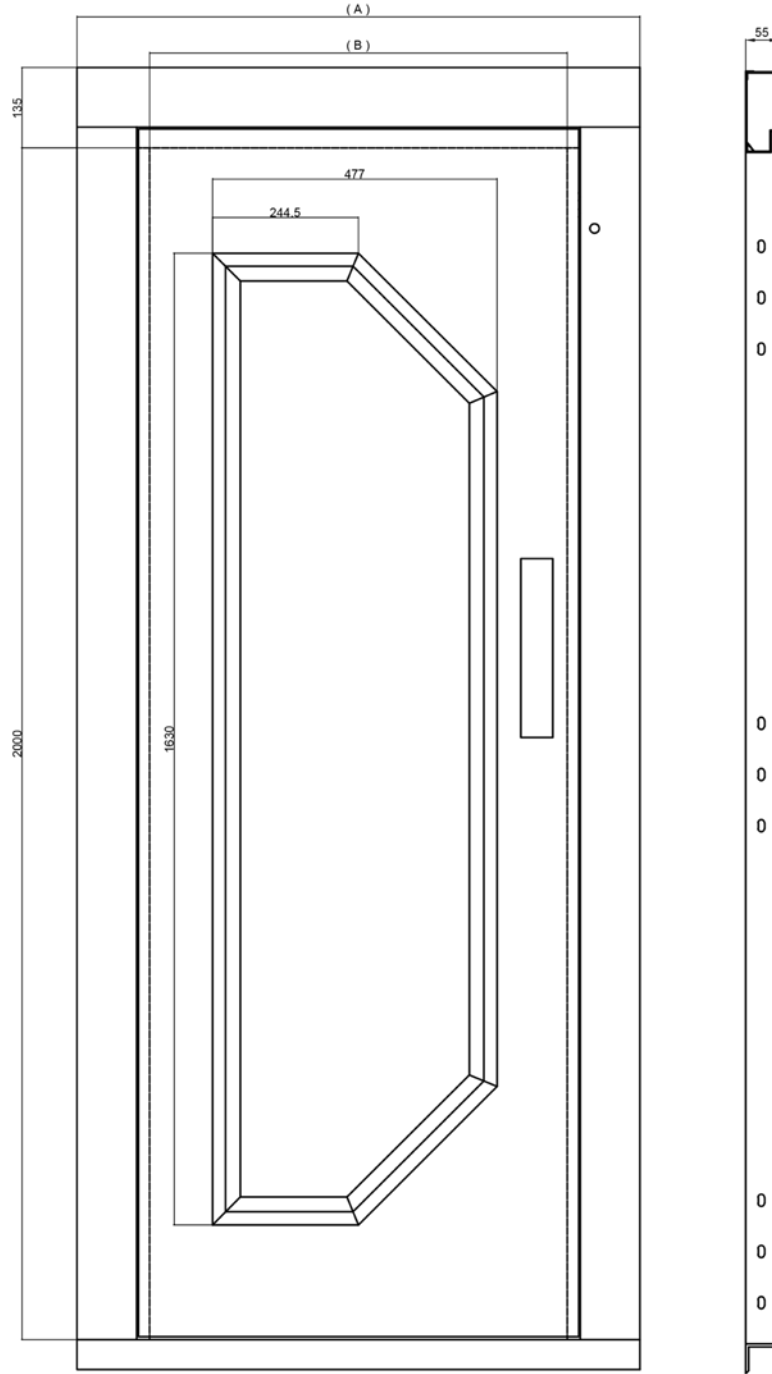

	A	B	
700mm KAPI / DOOR	944mm	700mm	GİRİŞ YÜKSEKLİK ENTRANCE HEIGHT 2000mm
800mm KAPI / DOOR	1044mm	800mm	
900mm KAPI / DOOR	1144mm	900mm	

DİĞER TALEP EDİLEN ÖLÇÜLER ÖZEL ÜRETİME GİRMEKTEDİR.
EXCEPT FROM THESE MEASUREMENTS ARE SPECIAL MANUFACTURING.

N MODEL
TEKNİK ÇİZİM
TECHNICAL DRAWING

* Diğer renk ve desen seçenekleri için 57 - 58' uncu sayfalara bakınız

* For other color and design preferences with this product you can see page between 57 - 58.

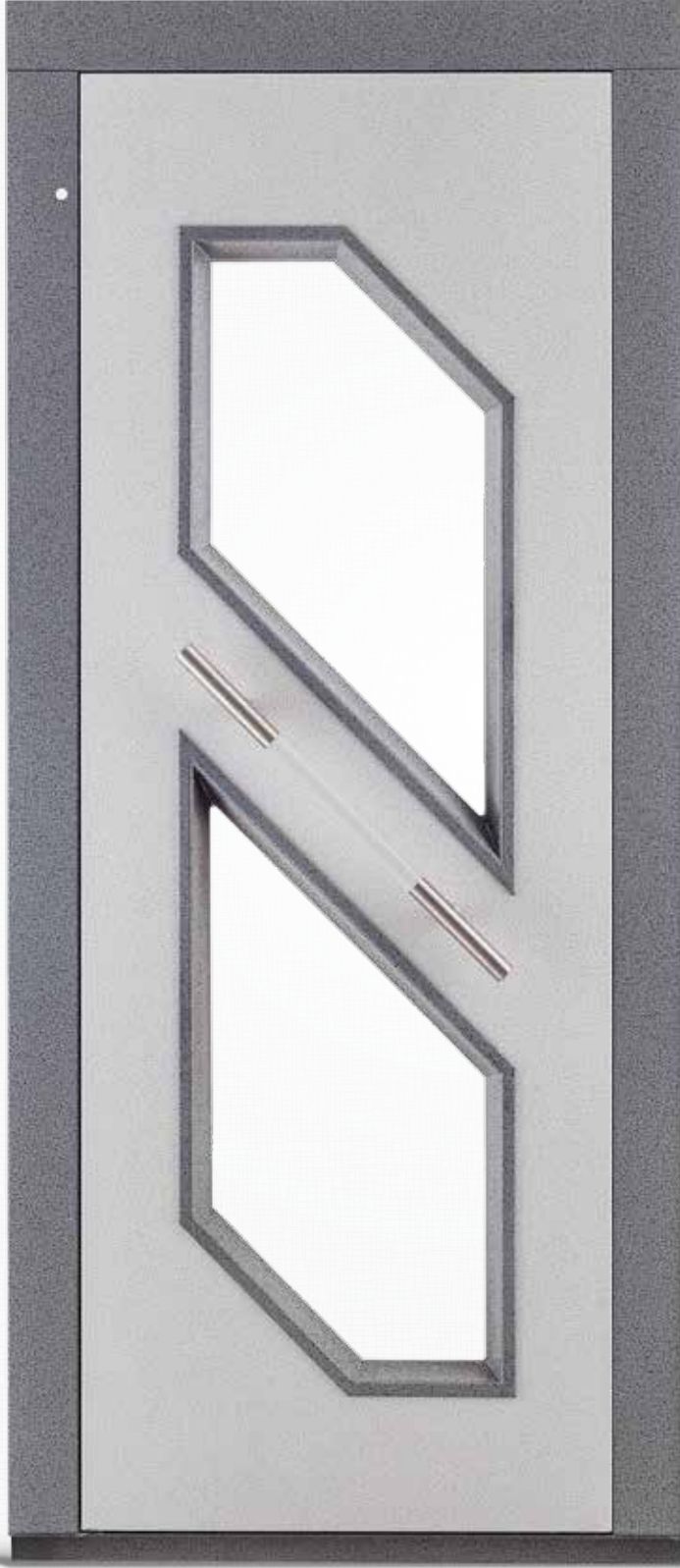

0 MODEL
YARI OTOMATİK KAPI
SEMI AUTOMATIC DOOR



1212



1616

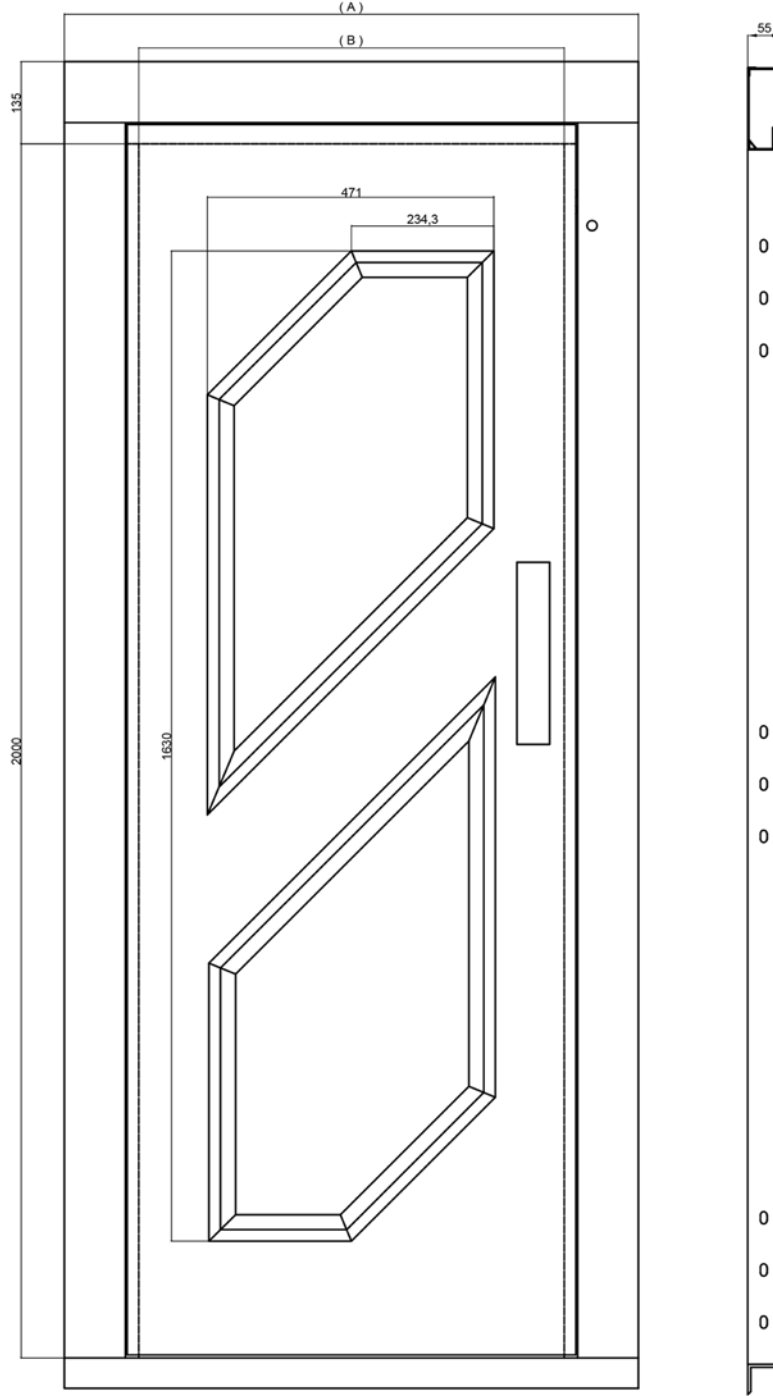

	A	B	
700mm KAPI / DOOR	944mm	700mm	GİRİŞ YÜKSEKLİK ENTRANCE HEIGHT 2000mm
800mm KAPI / DOOR	1044mm	800mm	
900mm KAPI / DOOR	1144mm	900mm	

DİĞER TALEP EDİLEN ÖLÇÜLER ÖZEL ÜRETİME GİRMEKTEDİR.
EXCEPT FROM THESE MEASUREMENTS ARE SPECIAL MANUFACTURING.

O MODEL
TEKNİK ÇİZİM
TECHNICAL DRAWING

* Diğer renk ve desen seçenekleri için 57 - 58' uncu sayfalara bakınız

* For other color and design preferences with this product you can see page between 57 - 58.



ÇİFT KANAT
DOUBLE WINGS
YARI OTOMATİK KAPI
SEMI AUTOMATIC DOOR

BAKIR
COPPER

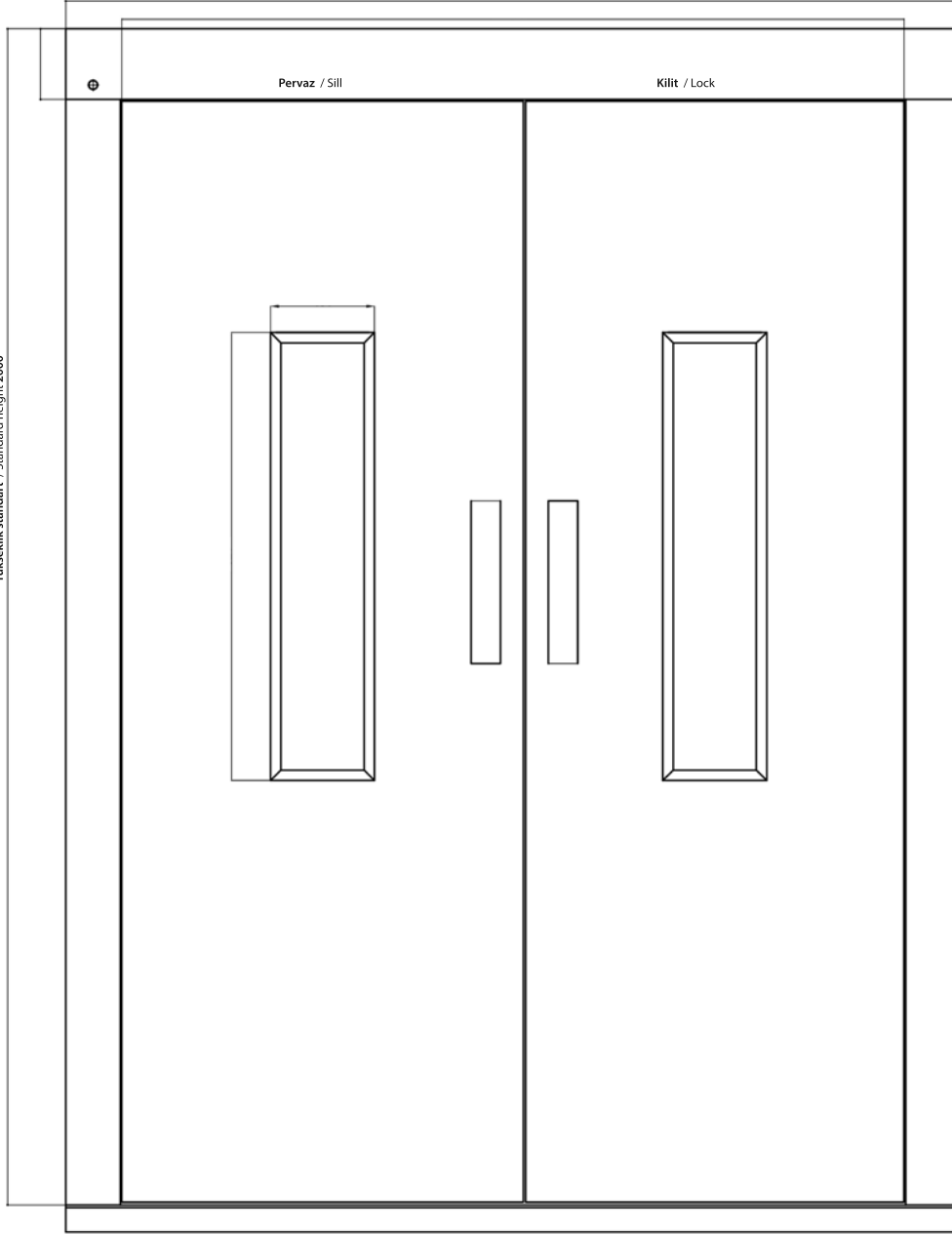

YÜKSEKLİK / HEIGHT	GİRİŞ / ENTRANCE	PERVAZ / SILL	KİLİT / LOCK
2000mm KAPI / DOOR	950mm	35mm	60mm
STANDART KAPI / STANDARD DOOR	1000mm	35mm	65mm
STANDART KAPI / STANDARD DOOR	1050mm	35mm	70mm
STANDART KAPI / STANDARD DOOR	1000mm	40mm	70mm
STANDART KAPI / STANDARD DOOR	1150mm	45mm	70mm
STANDART KAPI / STANDARD DOOR	1200mm	50mm	70mm
STANDART KAPI / STANDARD DOOR	1250mm	55mm	70mm
STANDART KAPI / STANDARD DOOR	1300mm	60mm	70mm
STANDART KAPI / STANDARD DOOR	1350mm	65mm	70mm
STANDART KAPI / STANDARD DOOR	1400mm	70mm	70mm
STANDART KAPI / STANDARD DOOR	1500mm	75mm	75mm
STANDART KAPI / STANDARD DOOR	1600mm	80mm	80mm
STANDART KAPI / STANDARD DOOR	1700mm	85mm	85mm
STANDART KAPI / STANDARD DOOR	1800mm	90mm	90mm
STANDART KAPI / STANDARD DOOR	1900mm	95mm	95mm
STANDART KAPI / STANDARD DOOR	2000mm	100mm	100mm
STANDART KAPI / STANDARD DOOR	2100mm	105mm	105mm
STANDART KAPI / STANDARD DOOR	2200mm	110mm	110mm

ÇİFT KANAT
DOUBLE WINGS

TEKNİK ÇİZİM
TECHNICAL DRAWING

* Diğer renk ve desen seçenekleri için 57 - 58'uncu sayfalara bakınız

* For other color and design preferences with this product you can see page between 57 - 58.



* Bu ürün için lütfen bizimle irtibata geçiniz.
* Please contact us for special design industrial door.

ÖZEL TASARIM
ENDÜSTRİYEL

SPECIAL DESIGN
INDUSTRIAL DOORS

YARI OTOMATİK KAPI
SEMI AUTOMATIC DOOR

TURKUAZ
TURQUASE

İşimiz sizi yükseklere taşımak / Our mission is to carry you up





PASLANMAZ
KAPLAMA

STAINLESS STEEL
COVERING

OTOMATİK KAPI
AUTOMATIC DOOR

PASLANMAZ
SATINE 304

* Diğer renk ve desen seçenekleri için 57 - 58' uncu sayfalara bakınız

* For other color and design preferences with this product you can see page between 57 - 58.



CEVİZ BOYAMA

WALNUT PAINTING

OTOMATİK KAPI
AUTOMATIC DOOR

CEVİZ
VOLNUT PAINTING

* Diğer renk ve desen seçenekleri için 57 - 58'uncu sayfalara bakınız

* For other color and design preferences with this product you can see page between 57 - 58.



* Dięer renk ve desen seęenekleri ięin 57 - 58' uncu sayfalara bakınız
* For other color and design preferences with this product you can see page between 57 - 58.

KAYIN BOYAMA

BEECH PAINTING

OTOMATİK KAPI
AUTOMATIC DOOR



KAYIN
BEECH PAINTING



RAL BOYALI

RAL PAINTING

OTOMATİK KAPI
AUTOMATIC DOOR

1014

* Diğer renk ve desen seçenekleri için 57 - 58'uncu sayfalara bakınız

* For other color and design preferences with this product you can see page between 57 - 58.



İşimiz sizi yükseklere taşımak / Our mission to carry you up



SATİNE KAPLAMA

STAINLESS STEEL
COVERING

KRAMER KAPI
KRAMER FOLDING DOOR

SATİNE
304



CEVİZ BOYAMA

WALNUT PAINTING

KRAMER KAPI
KRAMER FOLDING DOOR



CEVİZ
WALNUT PAINTING

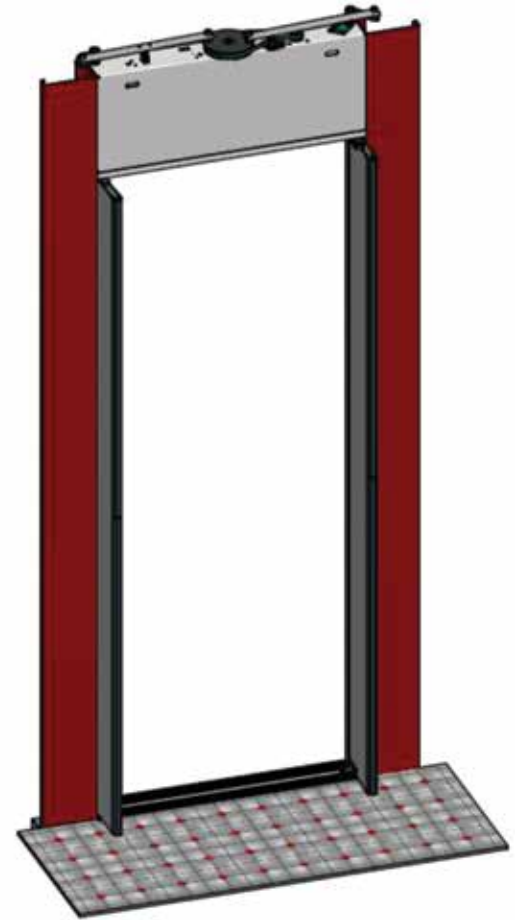
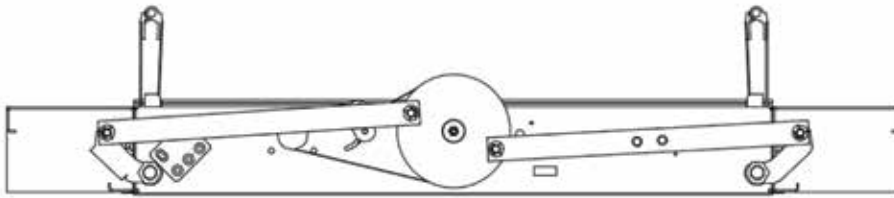
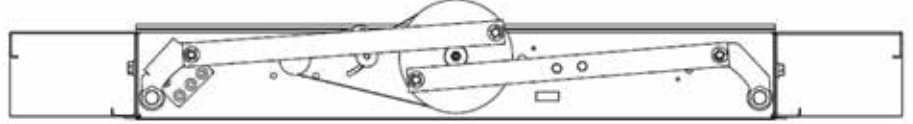
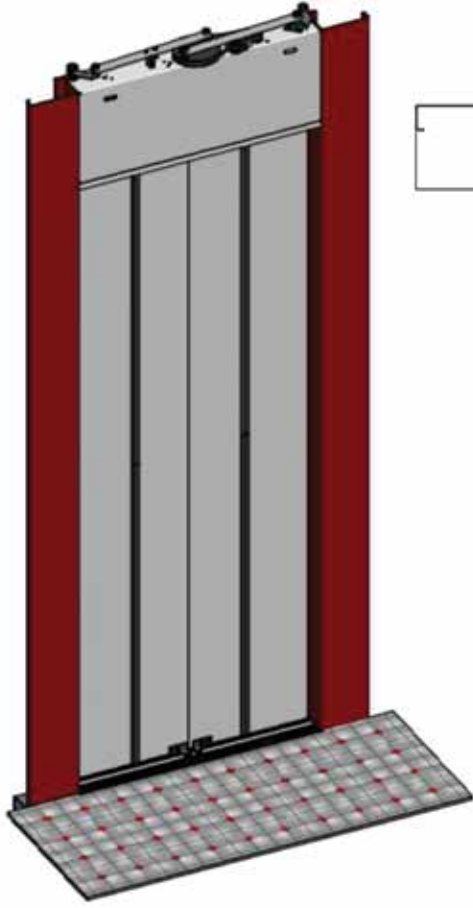

KRAMER KAPI
KRAMER FOLDING DOOR

TEKNİK ÇİZİM
TECHNICAL DRAWING

* Diğer renk ve desen seçenekleri için 57 - 58'uncu sayfalara bakınız

* For other color and design preferences with this product you can see page between 57 - 58.



Metale verilen ruh | Spirit given to metal

**TAŞIMA ARALIKLARI**

MIN	MAX
320 kg	630 kg
800 kg	1000 kg
1250 kg	1500 kg

KARKAS

HİDROLİK KARKAS
HYDROLIC CARCASS



Doorlife sizi yükseklere taşır / Doorlife moves you up

DİĞER ÜRÜNLERİMİZ / OTHER PRODUCTS

ARAÇ KALDIRMA
PLATFORMU

VEHICLE LIFTING PLATFORM

* Bu ürün için lütfen bizimle irtibata geçiniz.
* Please contact us for vehicle lifting platform.

■ **DİĞER ÜRÜNLERİMİZ / OTHER PRODUCTS**

■ **PANOLAR / CABINETS**



ÇİFT KANAT PANO
DOUBLE WINGS CABINETS



TEK KANAT PANO
SINGLE WING CABINETS

DİĞER ÜRÜNLERİMİZ / OTHER PRODUCTS**KORUMA KAPAKLARI / PROTECTION COVERS**

MOTOR KORUMA KAPAĞI
ENGINE PROTECTION COVER



KASNAK KORUMA KAPAĞI
PULLEY PROTECTION COVER



Kalitenin buluşma noktası / Meeting point of quality

DİĞER KAPI SEÇENEKLERİ / OTHER MODELS

DL A2S1

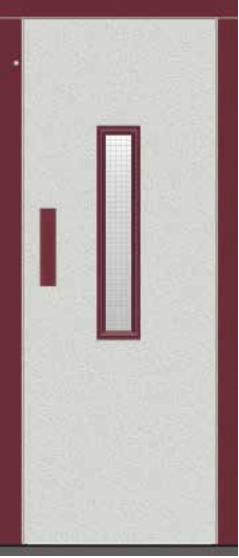

Kod: Ral 7032

Kod: Ral 3004

DL A2S1

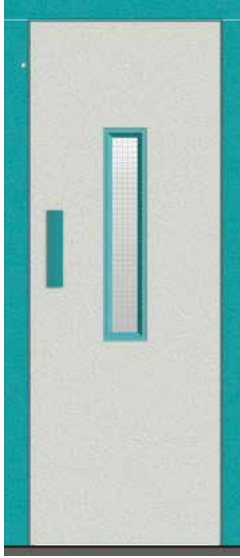

Kod: Ral 7032

Kod: Ral 5018

DL A2S1

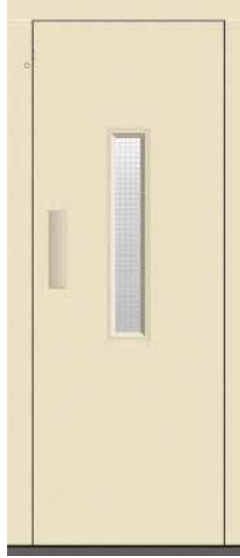

Kod: Ral 1013

DL A2S1



Kod: Ral 1013

Kod: Ral 1001

DL A2S1



Kod: Ral 1015

Kod: Ral 3012

DL A2S1

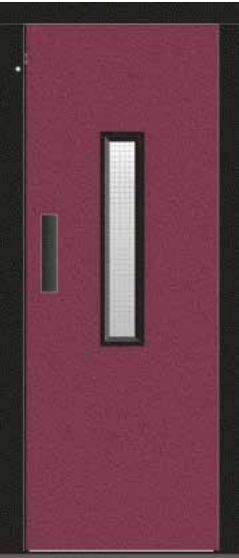

Kod: Ral 3004

Kod: Ral 9005

DL A2S1

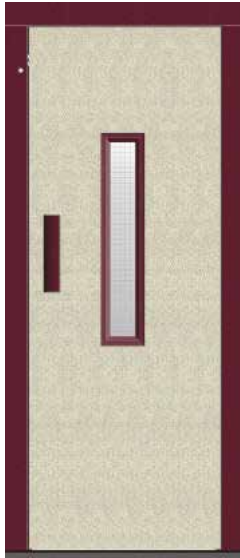

Kod: Ral 2020

Kod: Ral 2424

DL A2S1



Kod: Ral 2323

Kod: Ral 2222

DL A2S1

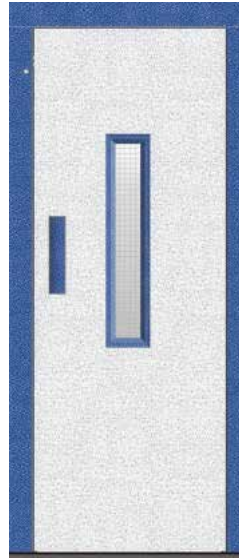

Kod: Ral 1616

Kod: Ral 2525

DL A2S1

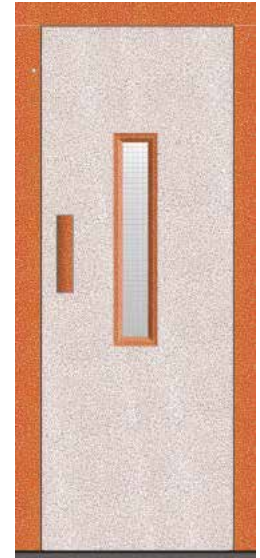

Kod: Ral 1515

Kod: Ral 1818

■ DİĞER KAPI SEÇENEKLERİ / OTHER MODELS

DL A4P1



Kod: Ral 5151

DL A4P1



Kod: Ral 5353

DL A2S1

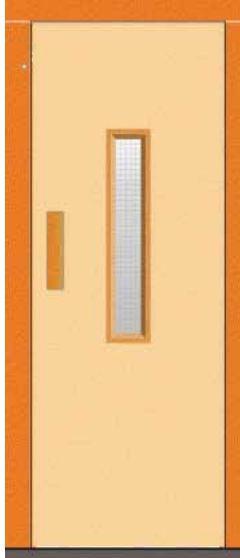

Kod: Ral 1034



Kod: Ral 2004

DL A2S1



Kod: Ral 1011



Kod: Ral 8017

DL A3S1

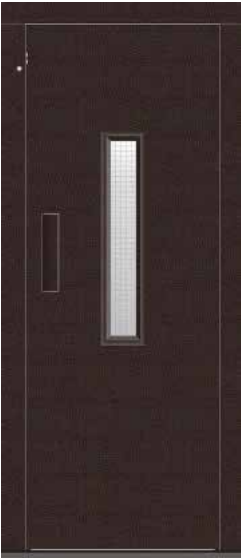

Kod: Ral 1111

DL A3S1



Kod: Ral 1212

DL A3S1

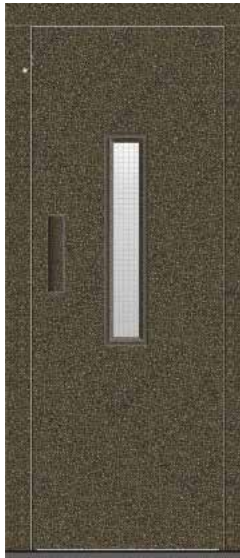

Kod: Ral 1313

DL A2S1



Kod: Ral 1616



Kod: Ral 1919

DİĞER KAPI SEÇENEKLERİ / OTHER MODELS

DL A2S1

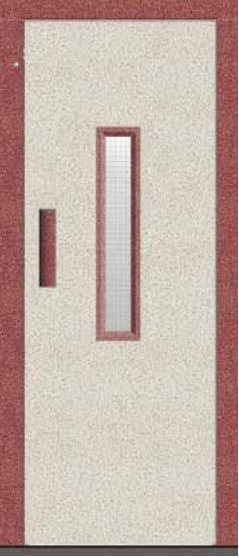

Kod: Ral 1717

Kod: Ral 1414

DL K4P1

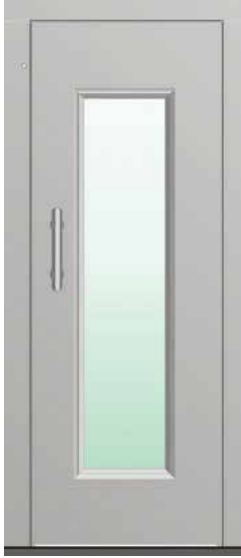

Kod: Ral 2626

DL A5S1



Kod: Ral 4040

DL A5S1



Kod: Ral 4141

DL F2F1

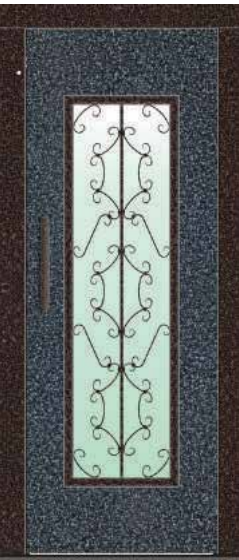

Kod: Ral 1212

Kod: Ral 1111

DL C3S1



Kod: Ral 2626

DL K2S1



Kod: Ral 6019

Kod: Ral 7001

DL K2S1



Kod: Ral 6013

Kod: Ral 6014

RENK SEÇENEKLERİ / RAL COLORS



Ral 1013



Ral 1014

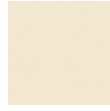

Ral 1015



Ral 1001



Ral 1002



Ral 7032



Ral 7035



Ral 7040



Ral 7001



Ral 9005



Ral 1018



Ral 1017



Ral 1028



Ral 1034

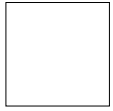

Ral 9016



Ral 1011



Ral 8003



Ral 8004



Ral 8017



Ral 9006



Ral 2001



Ral 2004



Ral 3004



Ral 3005



Ral 3012



Ral 6019



Ral 6011



Ral 6021



Ral 6013



Ral 6014



Ral 5018



Ral 5015



Ral 5010



Ral 3020



Ral 9069

ÖZEL RENK SEÇENEKLERİ / SPECIAL COLORS

SİMLİ BOYA / BROCADES

SİYAH SİM
(BLACK)GÜMÜŞ SİM
(GREY)

RENK SEÇENEKLERİ / RAL COLORS**KOD: 1111**
BAKIR DÖVME
(ANTIQUE CUPPER)**KOD: 1212**
GÜMÜŞ DÖVME
(ANTIQUE SILVER)**KOD: 1313**
ALTIN DÖVME
(ANTIQUE GOLD)**KOD: 1414**
KIRMIZI ALTIN DÖVME
(RED ANTIQUE GOLD)**KOD: 1515**
BEYAZ BAKIR DÖVME
(WHITE ANTIQUE CUPPER)**KOD: 1616**
BEYAZ GÜMÜŞ DÖVME
(WHITE ANTIQUE SILVER)**KOD: 1717**
BEYAZ ALTIN DÖVME
(WHITE ANTIQUE GOLD)**KOD: 1818**
TURUNCU ALTIN DÖVME
(ORANGE ANTIQUE GOLD)**KOD: 1919**
GRİ DÖVME
(ANTIQUE GREY)**KOD: 2020**
KREM DÖVME
(RED ANTIQUE CREAM)**KOD: 2121**
MEŞE DÖVME
(WHITE ANTIQUE OAK)**KOD: 2222**
CEVİZ DÖVME
(WHITE ANTIQUE WALNUT)**KOD: 2323**
GÜL
(ROSE)**KOD: 2424**
MAUN
(MAHOGANY)**KOD: 2525**
MAVİ GÜMÜŞ DÖVME
(BLUE ANTIQUE SILVER)**KOD: 2626**
KRİSTAL METALİK
(CRYSTAL METALLIC)**PASLANMAZ SEÇENEKLERİ / SPECIAL COLORS****KOD: 5050**
SATİNE**KOD: 5151**
NOKTA**KOD: 5252**
DERİ**KOD: 5353**
KARE DESEN**KOD: 5454**
DAMLA DESEN**KOD: 5555**
HİEROGLİF DESEN**AHŞAP SEÇENEKLERİ / WOODEN ALTERNATIVES****KOD: 4040**
MEŞE**KOD: 4141**
CEVİZ**KOD: 4242**
ORTA MEŞE**KOD: 4343**
KAYIN

KAPI MODELLERİ / DOOR MODELS

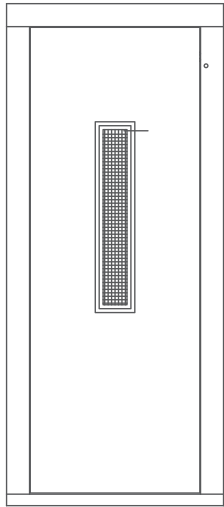

A

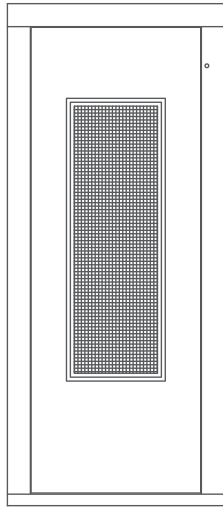

B

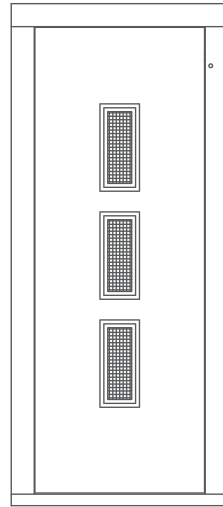

C

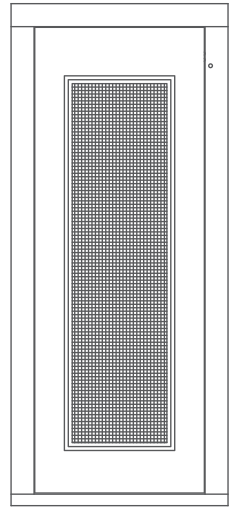

D

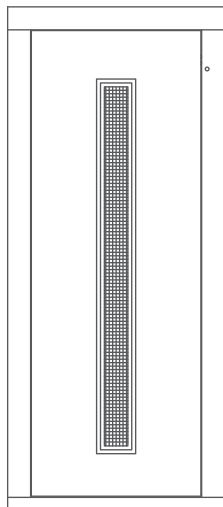

E

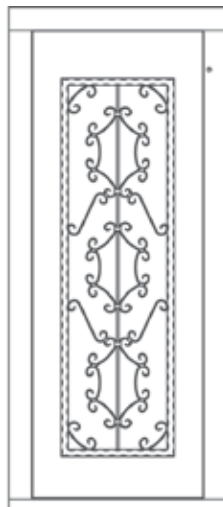

F

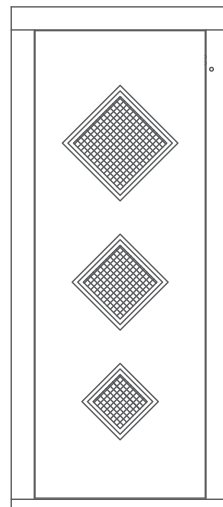

G

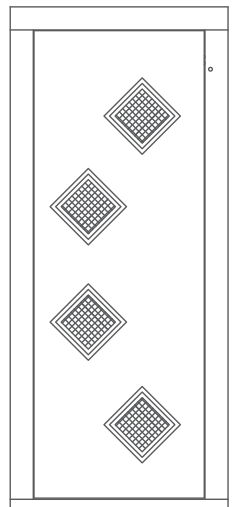

H

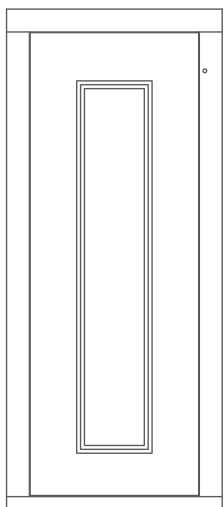

K

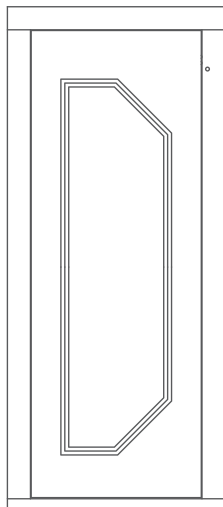

N

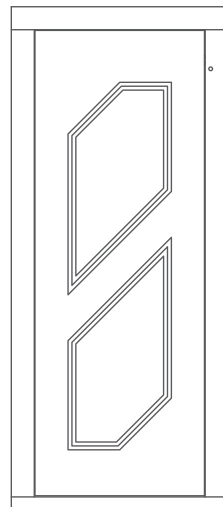

O

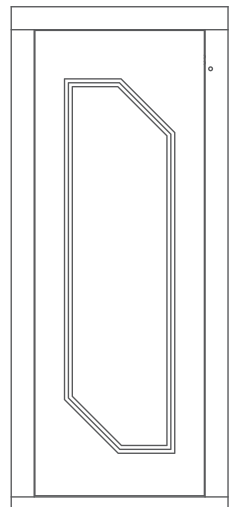

P

KOL MODELLERİ / HANDLE MODELS

Paslanmaz Boru Kollar Stainless Steel Tube Handles

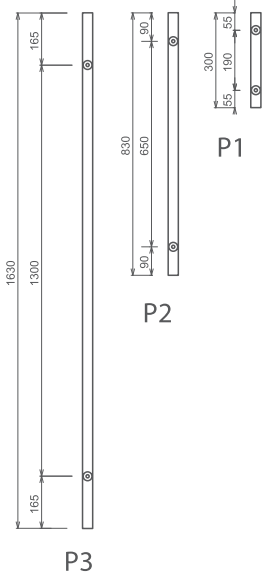

Standart Alüminyum Profil Kollar Standard Aluminium Profile Handles

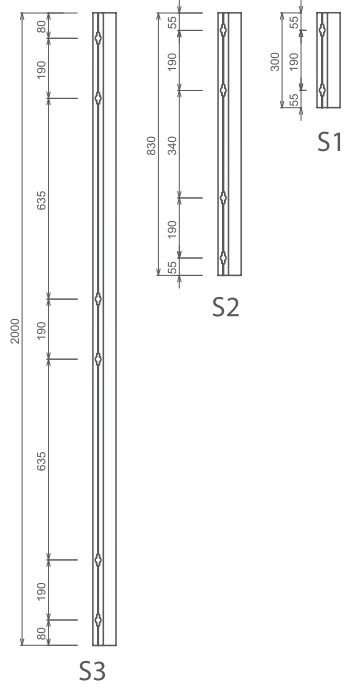

Perforje Dekoratif Kollar Decorative Handles

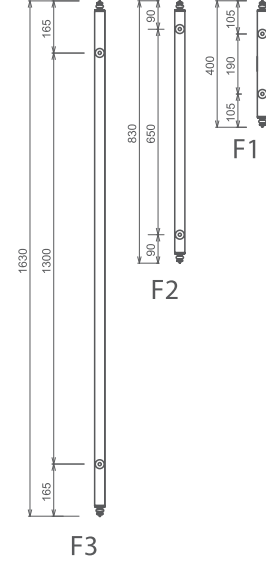

Kare Profil Paslanmaz Kollar Square Profile Stainless Handles

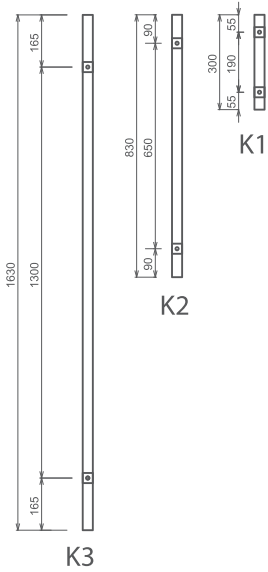

Static Toz Boya Kasa ve Çerçevesizle Aynı Renk Boru Kollar Tube Handles

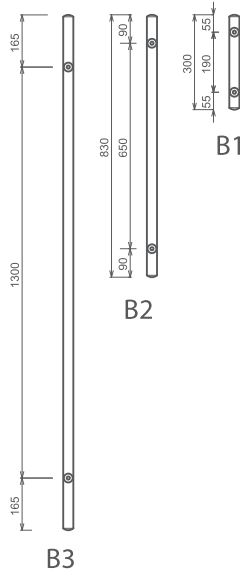

Özel Kollar Special Handles

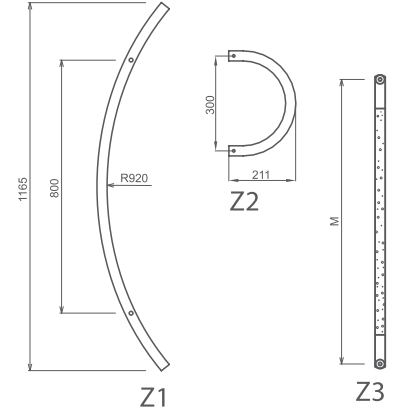

KODLAMA SİSTEMİ / CODE SYSTEM

KAPI MODELLERİ MODELS CODES

A
B
C
D
E
F
G
H
J
K
N
P
O

KAPI TİPLERİ / MODELS CODES

Ral Boyalı / Ral	1
Çift Renk / Double Color	2
Dövme Boyalı / Artique	3
Paslanmaz Kaplı / St Steel	4
Ahşap Kaplı / Lamine Covering	5
Simli Boya / Brocodes	6

KAPI KOLU KODLARI / HANDLE CODES

Standart Kol / Standard	S1
Standart Yarım / Standard Half Size	S2
Standart Tam / Standard Full Size	S3
Paslanmaz Kol / St Steel	P1
Paslanmaz Yarım / St Steel Half Size	P2
Paslanmaz Tam / St Steel Full Size	P3
Boru Kol / Tube	B1
Boru Yarım / Tube Half Size	B2
Boru Tam / Tube Full Size	B3
Kare Kol / Rectangular	K1
Kare Yarım / Rectangular Half Size	K2
Kare Tam / Rectangular Full Size	K3
Özel Kol / Special Handle	Z1
Özel Kavis / Special Curve	Z2
Özel Yay / Special Spring	Z3
Ferforje Kol / Wrought Iron	F1
Ferforje Yarım / Wrought Iron Half Size	F2
Ferforje Tam / Wrought Iron Full Size	F3

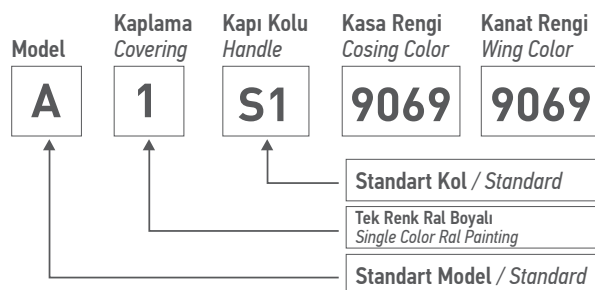
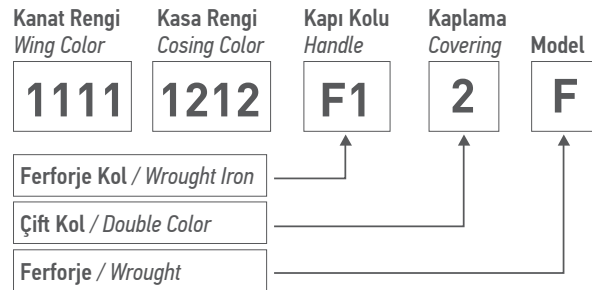

TEKNİK BİLGİLER / TECHNICAL INFORMATIONS

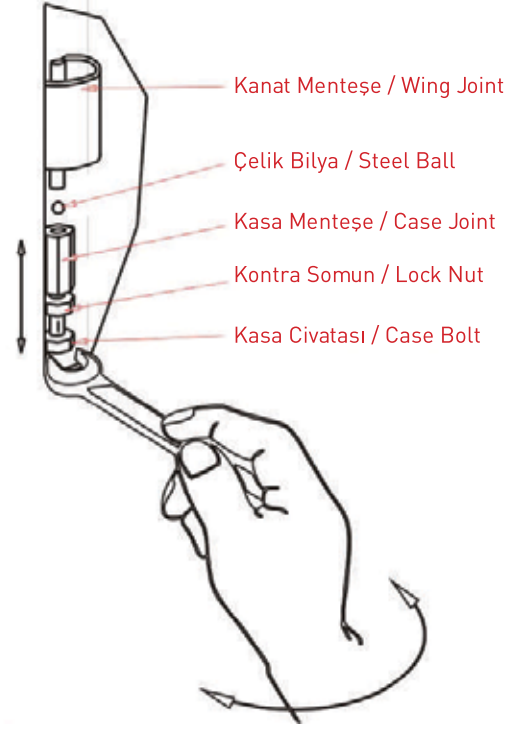
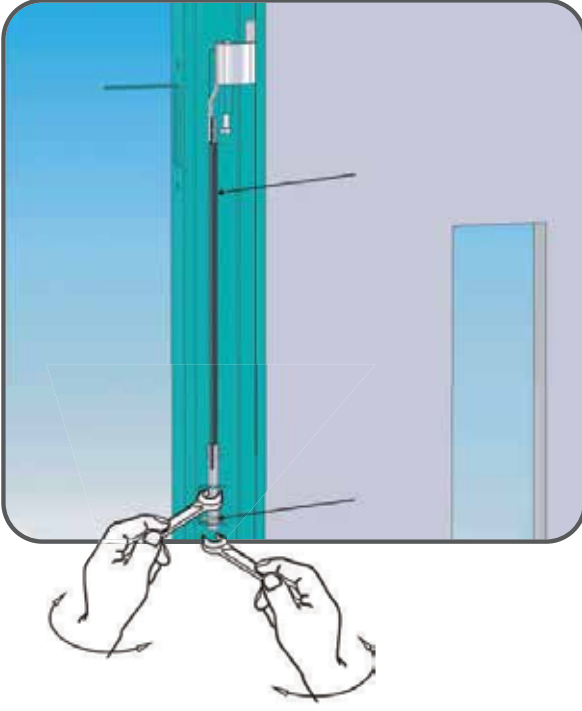

DİKKAT!

- Asansör kapısını sakuli kontrol edilmiş ve çarpıklığı giderilmiş olarak monte ediniz.
- Kapı kilit ve fiş kontağının yerine tam oturmasını sağlayınız.
- Kapı amortisörünü kanat üstüne monte ediniz.
- Kasa menteşesi içerisindeki çelik bilyanın yerinde olduğundan emin olunuz. Kasa civası ile kanadın aşağı yukarı hareketi sağlanarak ince ayarını yapınız. Somunu ile civatayı sabitleyiniz.
- Şakalinde/dengesinde olan asansör kapısı yayı takıldıktan sonra bir kaç tur kurarak yayın kapıyı çekmesini sağlayınız, altı köşe pulu ile yayı sabitleyiniz.
- Cam sıkıştırıcıları ile camı sabitleyiniz. Kapı çerçeve segmanlarını merkezleyerek yerine takınız.

CAUTION!

- Mount the elevator doors as the plumb line checked and the skewness has been corrected.
- Let the chips and the door lock to fit in place of contact.
- Mount shock absorbers of the door on the wing.
- Make sure that your steel ball is in the case nut. Make fine tuning by movement of the wings up and down by using case bolt. Fix the bolt with nut.
- Make sure after the spring is fixed, you set it a few rounds that the spring can haul the door which is on balance and fix the spring with hexaganol pul.
- Fix the glass with glass compression. Install the door frame segments in their places after centering them.

TEKNİK BİLGİLER / TECHNICAL INFORMATION

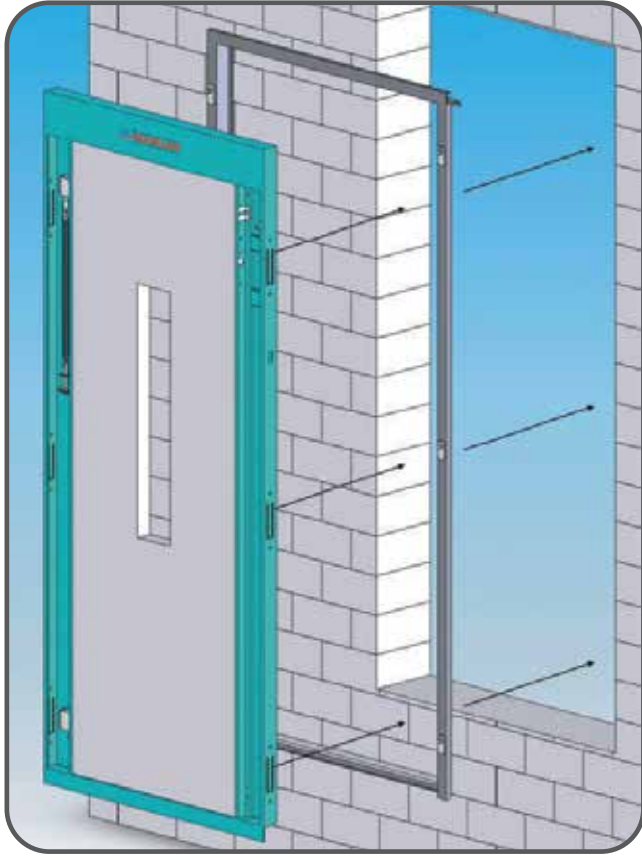

ŞEKİL - 1 Körkasalı Montajı / Mounting With Subframe

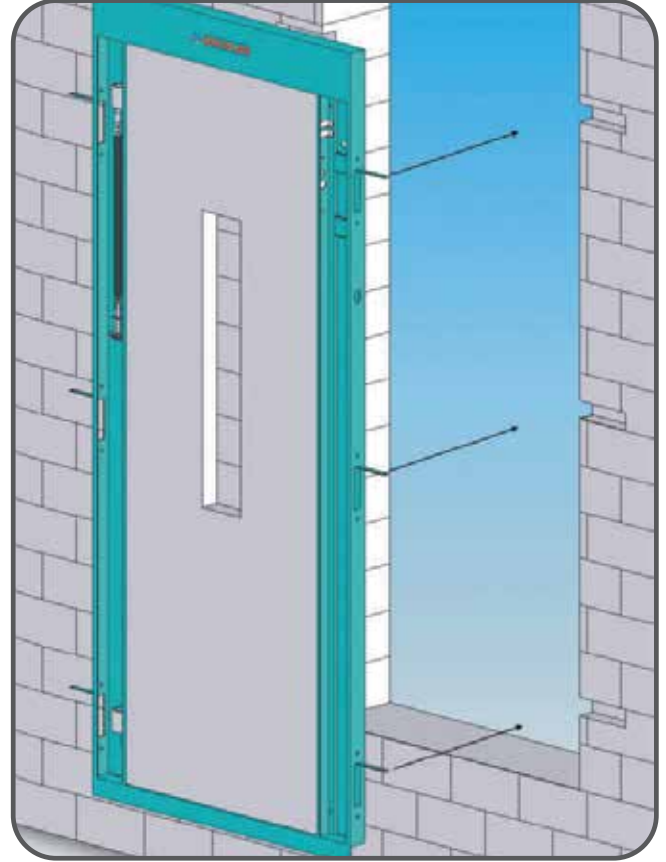

ŞEKİL - 2 Körkasasız Montajı / Mounting Without Subframe

STANDART KAPI BİLGİLERİMİZ

1. Kapı kanadı 1,2 mm kalınlığında A1 kalite DKP sactan imal edilir.
2. Kapı kasası 2 mm kalınlığında A1 kalite DKP sactan imal edilir. Kapının mukavemetini arttırmak için takviyelerle sabitlenir, isteğe ve kapı büyüklüğüne bağlı olarak sac kalınlığı değiştirilir.
3. Çerçeve ve kapı kolu alüminyumdan imal edilir.
4. Kapıların yüzey temizliği fosfatlama yapılarak elektrostatik toz boya ve fırınlama tekniği ile kaplanır.
5. Uyumlulukları kontrol edilen kilit ve amortisörler, shlink makinası ile toz ve nem almayacak şekilde ambalajlanır, bu sayede oksitlenmesi önlenmiş olur.

STANDARD DOOR INFORMATION

1. The door wing is made of 1,2 mm Thick A1 quality DKP iron sheet.
2. The doorcase is made of 2 mm thick A1 quality DKP iron Sheet. The door is reinforced in order to increase the strength. The thickness of the iron sheet changes according to the size of the door.
3. Lever surface cleaning of the door is made by phospatization electrostatic powder paint and baking technique.
4. The lock and shock absorbers whose the compatibility is checked are packed in a way they never get dust and moisture by shlink machine so that it isn't oxidized.

