

PRODUCTS CATALOGUE

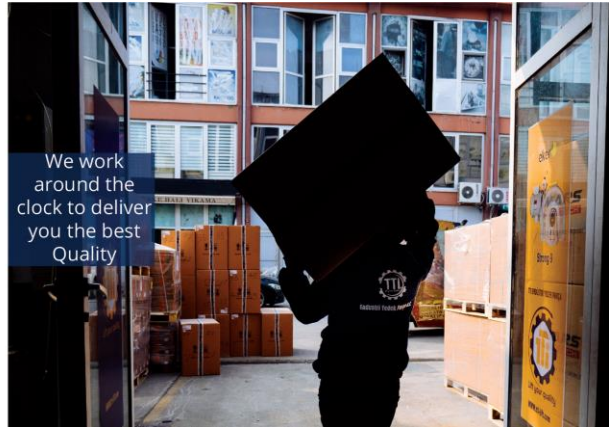

Turkish Technology & Industry
Endüstri Yedek Parça A.Ş.



We work
around the
clock to deliver
you the best
Quality

T-101a
Door Lock



Product Specifications

- Double safety lock for semi-automatic doors.
- Contract made from phosphor ,bronze & silver for maximum volt 250 volt & maximum current,0.5 amp.
- High quality of plastic injection and aluminum body with high efficiency working in different weather.
- We use high quality and plastic cover of plastic.
- Lock is working in two direction right and left.

T-101a
Door Lock

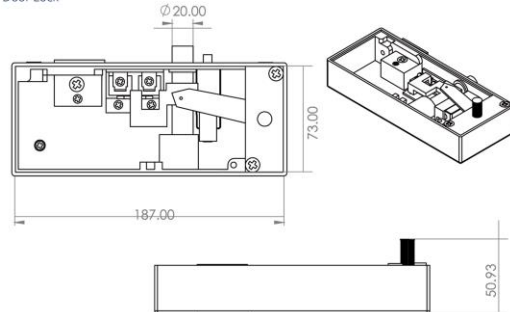

T-101b
Door Lock

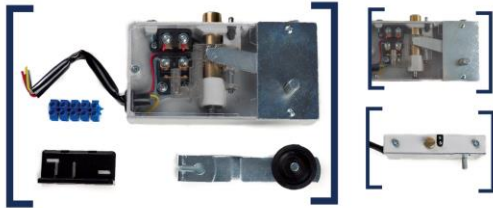

Product Specifications
 - Double safety lock for semi-automatic doors.
 - Contract made from phosphor - bronze & silver for maximum volt 230 volt & maximum current 0.5 amp.
 - High quality of plastic injection and aluminum body with high efficiency working in different weather.
 - We use high quality and elastic cover of plastic.
 - Lock is working in two direction right and left.
 - *Two years guarantee.

PAGE 4

WWW.TTILIFT.COM



T-102
Door Closer



Product Specifications
 - All products are made from high quality calibrated tube with high technology by CNC machine in production.
 - All parts protected against corrosion with very high hydraulic oil viscosity.
 - High accurate adjusting for all floors type.
 - Very strong materials are used for roller to avoid damage due to friction.
 - *Two years guarantee.

PAGE 6

WWW.TTILIFT.COM



T-103
RETIRING CAM



Product Specifications
 - Best materials with wider range in volt and adjustment distance.
 - Volt from 48V to 110V DC.
 - Full adjustment for speed and force.
 - Full adjustment for opening and closing distance.
 - Complete copper coil.
 - Operating capacity 240 times per hour continuously without interruption.
 - *Two years guarantee.

PAGE 8

WWW.TTILIFT.COM



T-109
ROPE HOLDER



Product Specifications
 - All parts protected against corrosion.
 - High quality cast iron.
 - *Two years guarantee.

PAGE 10

WWW.TTILIFT.COM



TF
Door Lock



Product Specifications
 - Double safety lock for semi-automatic doors.
 - Contract made from phosphor - bronze & silver for maximum volt 230 volt & maximum current 0.5 amp.
 - High quality of plastic injection and aluminum body with high efficiency working in different weather.
 - We use high quality and elastic cover of plastic.
 - Lock is working in two direction right and left.
 - *Two years guarantee.

PAGE 5

WWW.TTILIFT.COM



T-102
Door Closer

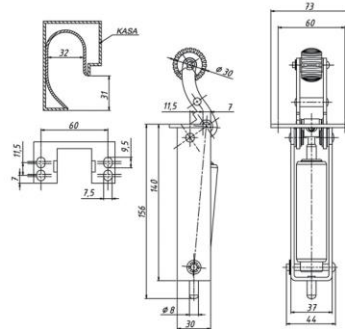

PAGE 7

WWW.TTILIFT.COM



T-103
RETIRING CAM

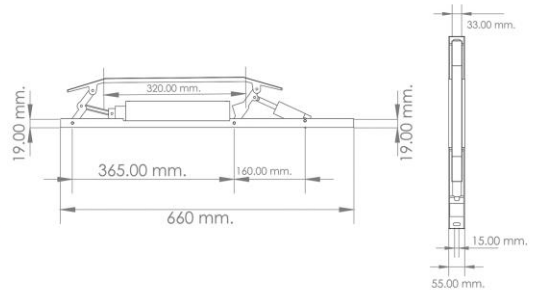

PAGE 9

WWW.TTILIFT.COM



TTI
LIFT YOUR QUALITY

Wide Production Range To Fulfill Your Requirement



T-104a
SPEED GOVERNOR



AVAILABLE TYPE:
A3 / UCM
MRL
NORMAL

Product Specifications

- Wide range of speed and high quality contact with manual reset.
- 0.8 to 2 m/sec speed range.
- High quality cast iron pulley and plastic cover.
- Right and left hand direction.
- *Two years guarantee

- GALVANIZE STEEL ZIPPER
- NICAL ZIPPER FOR LONG DISTANCE MOVEMENT
- WIDE RANGE FOR ADJUSTMENT
- SPECIAL PLASTIC FEELING RESISTANT FOR LONG LIFE

PAGE 13

WWW.TTILIFT.COM



T-104a
SPEED GOVERNOR

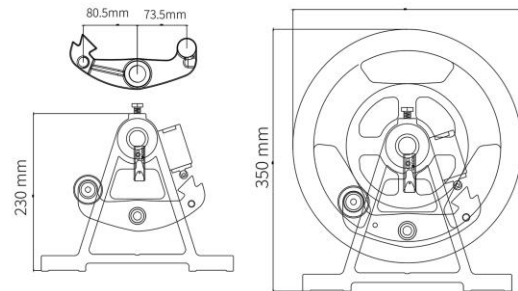

PAGE 14

WWW.TTILIFT.COM



T-104b
SPEED GOVERNOR



Product Specifications

- Wide range of speed and high quality contact with manual reset.
- 0.8 to 2 m/sec speed range.
- High quality cast iron pulley and plastic cover.
- Right and left hand direction.
- *Two years guarantee

PAGE 15

WWW.TTILIFT.COM



T-110
SPEED GOVERNOR HOLDER



Product Specifications

- Wide range of speed and high quality contact with manual reset.
- 0.8 to 2 m/sec speed range.
- High quality cast iron pulley and plastic cover.
- Right and left hand direction.
- *Two years guarantee

PAGE 16

WWW.TTILIFT.COM



T-105
MAGNETIC SWITCH



Product Specifications

- Strong long life product with very high sensitive switch.
- Respond of cutting the magnet from any place not just from the middle.
- 220 volt AC/DC
- 100VA N/O N/C
- *Two years guarantee

PAGE 17

WWW.TTILIFT.COM



T-106
MAGNETIC READ SWITCH



Product Specifications

- High sensitive Read switch made in Germany.
- N/O is responding from a distance of 40mm between the read switch and the magnet.
- N/C N/B are responding from the same distance.
- 220 volt AC/DC
- 100VA N/O N/C
- *Two years guarantee

PAGE 18

WWW.TTILIFT.COM



T-111
GUIDE SHOES

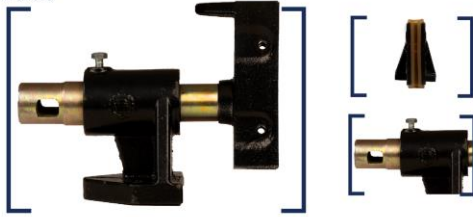

Product Specifications
- All parts protected against corrosion.
- High quality cast iron.
*Two years guarantee.

PAGE 19

WWW.TTILIFT.COM



T-111-B
GUIDE SHOES



Product Specifications
- All parts protected against corrosion.
- High quality cast iron.
- 5MM
*Two years guarantee.

PAGE 21

WWW.TTILIFT.COM



T101 A - B
SAFETY GEAR

- PRODUCE FROM HIGH - STRENGTH STEEL.
- ANTI - RUST TREATMENT.
- WHEELS ARE ANTI - CORROSION TREATMENT.
- 9MM / 16MM

SAFETY GEAR (T107 B) SAFETY GEAR (T107 A)



T107A / T107B
2 YEARS GUARANTI

PAGE 23

WWW.TTILIFT.COM



AUTO.DOOR.SPARE PARTS

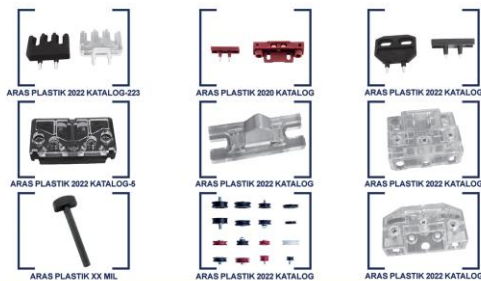

PAGE 25

WWW.TTILIFT.COM



T-112a
Plastic Filling

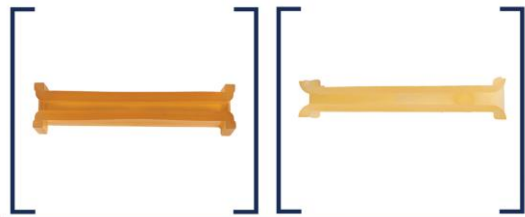

Product Specifications
- Very strong and high quality plastic material are used.
*Two years guarantee.

PAGE 20

WWW.TTILIFT.COM



T-112b
Plastic Filling

T - 113
GUIDE SHOES

- ALL PARTS PROTECTED AGAINST CORROSION.
- HIGH QUALITY CAST IRON.
- GALVANIZE STEEL ZIPPER.
- WIDE RANGE FOR ADJUSTMENT.
- SPECIAL PLASTIC FELING RESISTANT FOR LONG LIFE.
- ITALIAN MODEL.



T113
2 YEARS GUARANTI

PAGE 22

WWW.TTILIFT.COM



AUTO.DOOR.SPARE PARTS

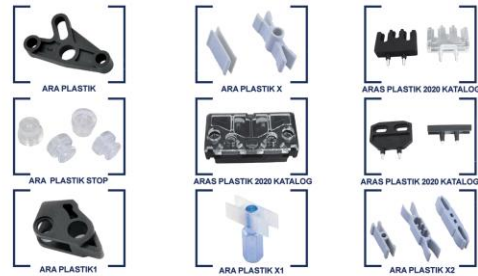

PAGE 24

WWW.TTILIFT.COM



AUTO.DOOR.SPARE PARTS

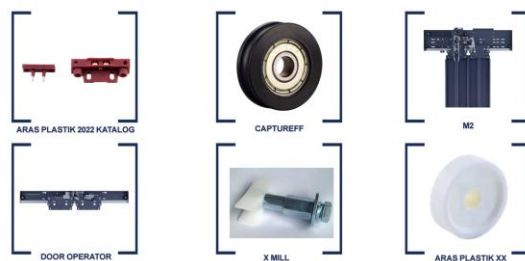

PAGE 26

WWW.TTILIFT.COM



OTHER SPARE PARTS



8909



TF DOOR LOCK



ARA OILER



DOORLIFE ELEVATOR - KATALOG_2018-9



ACCESS CONTROL



ARA GUIDE SHOES OTIS S



ARA HYDROLIC GUIDE SHOES 3



ARA HYDLIC BEAR2



ARA GUIDE SHOES OTIS

PAGE 27

WWW.TTILIFT.COM



OTHER SPARE PARTS



FOTOCL



DOORLIFE ELEVATOR - KATALOG_2018-19



DORTLU-ASANSOR-URUN-KATALOGU



BUTKON



CABIN / FLOOR PANELS



ELEVATOR BUFFER



FLEXIBLE CABLE FLAT



FOTOCL

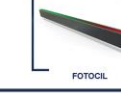

FOTOCL

PAGE 28

WWW.TTILIFT.COM



OTHER SPARE PARTS



GUIDE SHOES



GUIDE SHOES T003



WEIGHT SHOES T002



CLIPS (T1, T2, T3)

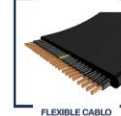

FLEXIBLE CABLE



OILER CUP

PAGE 29

WWW.TTILIFT.COM



Turkish Technology & Industry
Endüstri Yedek Parça A.Ş.



Endüstri Yedek Parça A.Ş.

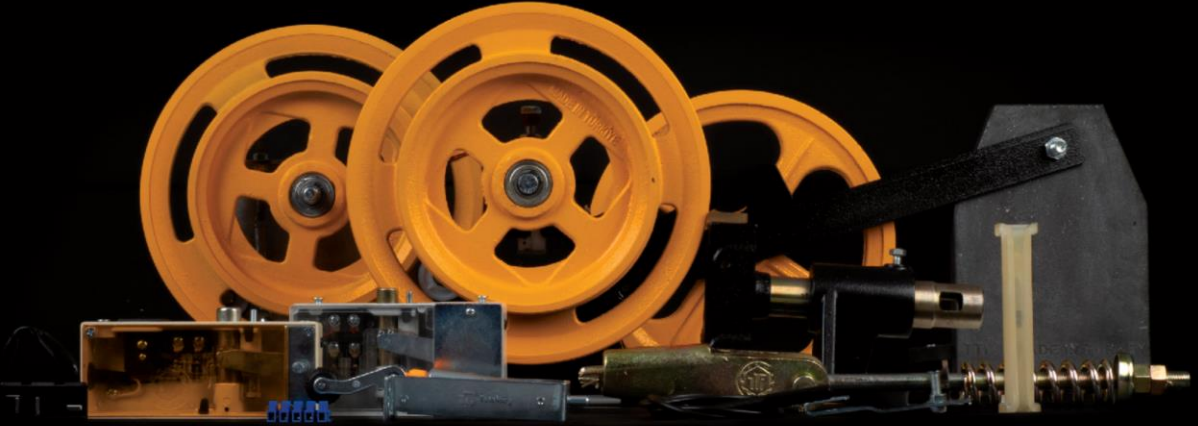

📍 Başak Mahallesi, İkitelli Mutsan San.
Sit., M10 Blok, No: 36-37-38, 34480,
34480 İkitelli Osb/Başakşehir

🌐 <https://www.ttilift.com>

☎ +90-212-532-4920
+90-544-412-4617
+90-542-340-7090

✉ info@ttilift.com